

**An Investigation to establish an injury profile in South African  
cyclists and its association to bicycle set-up.**

By

Barry - John Mills

Supervisor: Dr C.M.Korporaal (M.Tech: Chiropractic, CCFS, CCSP, ICSSD)

Co-Supervisor: Dr. A. Jones (M. Dip: Chiropractic, CCFC, CCSP)

## **DEDICATION**

This research is dedicated to my family and friends for their support and encouragement throughout my life.

## **ACKNOWLEDGEMENTS**

I am also grateful to the following people for their involvement and contribution to this research project:

1. Dr C.M.Korporaal for her supervision, enthusiasm and encouragement throughout my years involved in Chiropractic and the Chiropractic Student's Sports Association, both during work and after hours.
2. Dr A. Jones for his help and inspiration for Chiropractic, passion for patient wellness and for cycling.
3. Dr R. Mackey for her time and help with the data analysis and interpretation of the statistics.
4. The cycling fraternity, and friends made through this research.
5. Y.Kadwa and Dr H. Pooke.
6. Members of the focus group for participating in this study
7. D. Weyer –Henderson "Donner" : I'm sure you are flying with the angels!
8. To all my friends: Do not go where the path leads,  
Go instead where there is no path and leave a trail  
- Ralph Waldo Emerson

## GLOSSARY OF TERMS:

**Ankling:** many cyclists correct with exaggerated plantar flexion or dorsiflexion of the ankle, (Souza1996) (see Fig. 2.7)

**Bicycle set up:** According to Pfeiffer and Kronisch (1995), this includes: the bicycle design, terrain and safety equipment associated with the cyclist.

**Bottom Bracket:** the component at which the cranks attach to the bicycle (Coppolillo, 2000).

**Comfort:** A number of aspects that deal with comfort consisting of the parts of the body that make contact with the bicycle i.e: saddle, handlebars and pedals. These three parts play an important role in adjusting the bicycle, rather than frame size.

(<http://bicyclefitting.com/English/Theory/Comfort.aspx> )

**Compact frame:** a frame with a sloping top tube allowing for a smaller, stiffer frame, which is a popular design for mountain cyclists. (Burke and Pruitt, 2003).

**Crank length:** is the distance from the centre of the bottom bracket axle to the centre of the pedal axle

(<http://bicyclefitting.com/English?Theory/Crank.aspx>).

**Crepitus:** a dry, crackling sound or sensation, such as those produced by the grating ends of a fracture (Dorlands, 1995)

**Derailleur:** A device for shifting gears on a bicycle by moving the chain between sprocket wheels of different sizes.

(<http://dictionary.reference.com/search?q=derailleur>)

**Efficiency:** Determined by 5 interrelated factors namely: cadence, crank length, seat angle, saddle height and longitudinal foot position.

(<http://bicyclefitting.com/English/Theory/Efficiency.aspx>)

**Ischial Tuberosity:** a bony swelling on the posterior part of the superior ramus of the Ischium that gives attachment to various muscles and bears the weight of the body in sitting

(<http://dictionary.reference.com/search?q=ischial%20tuberosity>)

**Lordosis:** an increased curvature of the vertebral column that is convex anteriorly (Moore1992).

**Muscle Fibers:** classified as type I and type II. Type I fibres have slow contraction times but have a higher potential for oxidative metabolism (endurance activities) Type II, have a higher glycolytic capacity, thus are employed for sprinting and motor skills. (Sherry and Wilson, 1998).

**Power maximization:** Is obtained by placing the cyclist in a position that yields a high percentage of effective power. As seen in Figure 1.1, power vertically over the pedal arm is most effective at (1), while at the lowest position of the pedal stroke results are almost negligible. When the crank is at the 90-degree position, the adjustment of the bicycle so that the power is used. Forward and backward adjustment of the saddle plays a role. If the saddle is too far back, it results in a pedal position that corresponds to (2). If the saddle is placed too far forward, the pedals will correspond with (3).

(<http://bicyclefitting.com/English/Theory/PowerMax.aspx>)

Key: - Blue arrow: Power  
- Green arrow: Effective power  
- Red arrow: Loss of Power

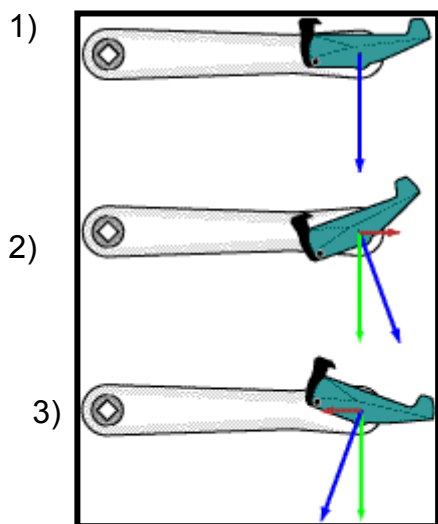
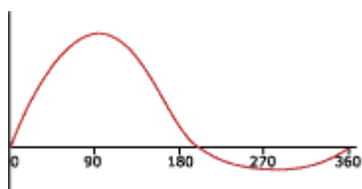

Figure 1.1 Diagram showing power Distribution on a Bicycle Pedal

The power that is exercised exactly under a 90 degrees angle on the crank is the most effective.



The red line, in Graph 1.1 represents the effective pedal load during 1 rotation, starting at the top dead point (12 o' clock).

Graph 1.1: Pedal Load

- Reach:** the distance from the saddle to the transverse part of the handle bar (Mellion, 1991).
- Resistance:** Transmission resistance: caused by the mechanical parts of the bicycle, which convert power to speed, and uses up 3 to 5% of the cyclists capacity. Roll resistance occurs due to deformation of the tyres, as the result of the weight of the cyclist and bicycle as well as irregularities in the road. Deformation costs the cyclist energy, which increases as the speed increases (e.g: at 44km/h on a smooth road in windless conditions, the roll resistance amounts to about 12%) (<http://bicyclefitting.com/English/Theory/Resistance.aspx>).

## **ABSTRACT**

### **Objectives**

The first objective was to investigate the injury profiles of South African cyclists, especially those relating to mountain bicycle use on the road, as there appears to be no knowledge available on mountain bicycle use on the road and related injuries. Secondly, to see if there is an association between injuries and bicycle set-up in a South African context.

### **Methods**

A non-probability purposive sampling technique was used to attract 125 cyclists. Stratification was utilized in order to compare between

- 1) Road bikes
- 2) Mountain bikes on-road

When the sample size of 125 was reached, 49 male road cyclists, 25 female road cyclists, and 25 male mountain bike cyclists on road and 26 female mountain bike cyclists on road participated in the study.

Questionnaire data and clinical examination of 125 cyclists were used to take a snapshot of the state of the cyclists' injury profiles at the time of the study.

To determine whether the different aspects of the cyclist (e.g., gender, dimension and cycling behaviour), bicycle type, bicycle dimensions, and bicycle set-up, as collected in the questionnaire, significantly affect the occurrence and likelihood of specific injuries, logistic regression analyses were performed.

All analyses were performed using SPSS 11.0. Statistical significance was set at  $p < 0.05$ .

### **Results**

*Injury profiles* for each bicycle type and gender (Table 4.1). Lower limb complaints were the most common for road cyclists (74%) and head/neck/thoracic/rib complaints were the most frequent for cyclists on mountain bikes (61%).

*Cycling complaints.* The odds of having injuries related to the head/neck/thoracic/rib region increased by 90% for each size too large the bike is for the cyclist (e.g., 90% increase if large bike is ridden instead of medium, 180% increase if extra-large is ridden instead of medium).

For injuries to the lower back and buttocks, the odds increased by 0.7% for each additional kilometre ridden per week.

Lower limb injuries were more probable for platform pedals and platform pedals with cages (odds were 47% greater than those for non-platform pedals) (Table 4.2).

*Clinical Presentations:* The odds of head/neck/thoracic region injuries were greatest for cyclists who used aluminium forks (76% increase in odds over other fork materials)

Injuries involving the pelvis, lumbar, Erector Spinea, Quadratus Lumborum muscles, and Sacro-Iliac joints increased 7.8% for each 1 cm reduction in the difference between handlebar and shoulder width.

Injuries to the lower limb, Rectus Femoris, Iliopsoas, and Gluteus Medius muscles had increased 8.6% for each 1-cm reduction in (handlebar width – shoulder width). Myofascial injuries, the odds increased 1% for each additional km ridden per week. The odds of SI syndrome increased 0.7% for each additional km ridden per week.

### **Conclusion**

Lower limb complaints were the most common for road cyclists and head/neck/thoracic/rib complaints were the most frequent for cyclists on mountain bikes, and pelvis/lumbar injuries were the most frequently assessed for both road and mountain bike riders (Table 4.1). In terms of specific anatomical locations, lower back, neck and knee complaints were the most common for road bike riders (Table 4.1). For mountain bikers riding on the road, lower back, knee, and hand complaints were the most common. There were sufficient Myofascial and Sacro-Iliac joint syndrome presentations to allow for comparisons between genders and bike types. Both conditions were more frequently assessed for males versus females and for road bikes versus mountain bikes (Table 4.1).

The most common variables in the logistic regression when looking at the association between injuries and bicycle characteristics in a South African context, were bike type: road, higher tyre pressures, higher average mileage per week (km/wk), lower stem angle and more time on the bike (hrs/week). This study is to my knowledge the first looking at mountain bike use on road and thus serves as a forerunner to more research that is surely to follow.

<b><u>TABLE OF CONTENTS</u></b>	<b>PAGE</b>
<b>DEDICATION</b>	<b>2</b>
<b>GLOSSARY OF TERMS</b>	<b>3</b>
<b>ABSTRACT</b>	<b>6</b>
<b>TABLE OF CONTENTS</b>	<b>8</b>
<b>LIST OF APPENDICES</b>	<b>11</b>
<b>LIST OF TABLES AND CHARTS</b>	<b>12</b>
<b><u>CHAPTER ONE – INTRODUCTION</u></b>	<b>13</b>
<b>1.1 INTRODUCTION</b>	<b>13</b>
<b>1.2 THE OBJECTIVES OF THIS STUDY</b>	<b>15</b>
<b>1.3 RATIONALE FOR THE STUDY</b>	<b>15</b>
<b>1.4 LIMITATIONS OF THE STUDY</b>	<b>16</b>
<b>1.5 BENEFITS OF THE STUDY</b>	<b>16</b>
<b><u>CHAPTER TWO – REVIEW OF THE RELATED LITERATURE</u></b>	<b>17</b>
<b>2.1. INCIDENCE OF BICYCLE RELATED INJURIES</b>	<b>17</b>
<b>2.2 RISK FACTORS FOR INJURY</b>	<b>18</b>
<b>2.3 AN OVERVIEW OF THE CURRENT LITERATURE- BICYCLE ANATOMY</b>	<b>19</b>
<b>2.4 CORRECT BICYCLE SET-UP OR FIT</b>	<b>23</b>
<b>2.5 INJURIES TO CYCLISTS</b>	<b>37</b>
<b>2.6 MOST COMMON ANATOMICAL SITES FOR OVERUSE INJURIES/COMPLAINTS</b>	<b>39</b>
<b>2.7 INJURY PREVENTION</b>	<b>54</b>



<b><u>CHAPTER THREE – MATERIALS AND METHODS</u></b>	<b>56</b>
<b>3.1 BACKGROUND OF THIS STUDY</b>	<b>56</b>
<b>3.2 THE FOCUS GROUP DISCUSSION / FORUM</b>	<b>57</b>
<b>THE ANALYSIS OF THE FOCUS GROUP DISCUSSION</b>	
<b>-THEMES EXTRAPOLATED</b>	
<b>3.3 DATA COLLECTION</b>	<b>60</b>
<b>3.3.1 PARTICIPANT RECRUITMENT</b>	<b>60</b>
<b>3.3.2 STUDY PROTOCOL AND DESIGN</b>	<b>61</b>
<b>3.3.2.1 ALLOCATION OF SUBJECTS</b>	<b>61</b>
<b>3.3.2.2 SAMPLE SIZE</b>	<b>61</b>
<b>3.3.2.3 SAMPLE ALLOCATION</b>	<b>61</b>
<b>3.3.2.4 CRITERIA FOR ACCEPTANCE OF</b>	<b>62</b>
<b>COMPLETED QUESTIONNAIRES</b>	
<b>3.3.2.4.1. PATIENT INCLUSION CRITERIA</b>	<b>62</b>
<b>3.3.2.4.2. PATIENT EXCLUSION CRITERIA</b>	<b>62</b>
<b>3.3.2.4.3.INCLUSION OF THE QUESTIONNAIRE</b>	<b>62</b>
<b>3.3.2.4.4.EXCLUSION OF THE QUESTIONNAIRE</b>	<b>62</b>
<b>3.3.2.5.CONFIDENTIALITY CLAUSES</b>	<b>63</b>
<b>3.3.2.5.1.FOCUS GROUP CONFIDENTIALITY</b>	<b>63</b>
<b>3.3.2.5.2.PATIENT CONFIDENTIALITY,</b>	<b>63</b>
<b>IN TERMS OF THE INFORMATION DATABASE</b>	
<b>3.3.2.6.DETAILED DATA COLLECTION AND THE</b>	<b>63</b>
<b>INTERPRETATION PROCEDURE</b>	
<b>3.3.2.6.1.CLINICAL PROCEDURE</b>	<b>63</b>
<b>3.4. DATA ANALYSIS</b>	<b>64</b>
<b>3.4.1.INJURY PROFILE</b>	<b>64</b>
<b>3.4.2.INJURIES VS. CYCLIST AND BICYCLE</b>	<b>64</b>

<b><u>CHAPTER FOUR – RESULTS</u></b>	<b>66</b>
4.1. INJURY PROFILES	66
4.2. CONDITIONS THAT INCREASE THE ODDS OF INJURY	67
<b><u>CHAPTER FIVE – DISCUSSION AND CONCLUSION</u></b>	<b>77</b>
<b><u>CHAPTER SIX- RECOMMENDATIONS AND FUTURE RESEARCH</u></b>	<b>83</b>
<b><u>REFERENCES</u></b>	<b>85</b>

## **LIST OF APPENDICES**

### **Focus Group**

<b>APPENDIX A: LETTER OF INFORMATION-FOCUS GROUP</b>	<b>89</b>
<b>APPENDIX B: CONFIDENTIALITY STATEMENT DECLARATION – FOCUS GROUP</b>	<b>90</b>
<b>APPENDIX C: INFORMED CONSENT FORM – FOCUS GROUP</b>	<b>91</b>
<b>APPENDIX D: CODE OF CONDUCT – FOCUS GROUP</b>	<b>92</b>
<b>APPENDIX E: QUESTIONNAIRE (Dr. C.M. Korporaal)</b>	<b>93</b>
<b>APPENDIX F: THE FOCUS GROUP DISCUSSION- TRANSCRIPT OF THE TAPE RECORDINGS</b>	<b>95</b>
<b>APPENDIX G: CYCLISTS' QUESTIONNAIRE</b>	<b>111</b>

### **Clinical procedural appendices**

<b>APPENDIX H: CASE HISTORY</b>	<b>116</b>
<b>APPENDIX I: PHYSICAL</b>	<b>120</b>
<b>APPENDIX J: REGIONAL</b>	<b>121</b>
<b>APPENDIX K: S.O.A.P.E. NOTE</b>	<b>121</b>
<b>APPENDIX L: ADVERT</b>	<b>122</b>

### **Participant information in current study**

<b>APPENDIX M: LETTER OF INFORMATION</b>	<b>123</b>
<b>APPENDIX N: INFORMED CONSENT FORM</b>	<b>125</b>
<b>APPENDIX O: DETAILS OF CYCLISTS</b>	<b>126</b>

## **LIST OF TABLES AND FIGURES**

<b>Table 2.1:</b> Road bicycle sizing	<b>24</b>
<b>Table 2.2:</b> Crank length according to leg length/Inseam Length	<b>35</b>
<b>Table 2.3:</b> Crank length- height as a determinant	<b>35</b>
<b>Table 4.1:</b> Injury profile by gender and bicycle type	<b>70</b>
<b>Table 4.2:</b> Significant relationships observed in logistic regression analyses comparing the odds of patients with vs. without complaints	<b>72</b>
<b>Table 4.3:</b> Significant relationships observed in logistic regression analyses comparing the odds of patients with vs. without clinical presentations	<b>74</b>
<b>Table 4.4:</b> Cyclist and bike characteristics for gender and bicycle groups	<b>126</b>
<b>Table 4.5:</b> Cyclist and bike characteristics (mean $\pm$ standard error) for gender and bicycle groups	<b>128</b>
<b>Figure 1:</b> Drawing of the components of the bicycle	<b>19</b>
<b>Figure 2:</b> Optimal Saddle height using method 2	<b>26</b>
<b>Figure 3:</b> Demonstration of Optimal height using method 4	<b>27</b>
<b>Figure 4:</b> Demonstration of top tube length and reach	<b>30</b>
<b>Figure 5:</b> Road bicycle handle bar position	<b>31</b>
<b>Figure 6:</b> Mountain bike handle bar position	<b>31</b>
<b>Figure 7:</b> Saddle Tilt	<b>34</b>
<b>Figure 8:</b> Crank Arm Length	<b>34</b>
<b>Figure 9:</b> Diagram showing correct foot position	<b>36</b>
<b>Figure 10:</b> Diagram showing ankling	<b>49</b>

## **CHAPTER 1**

### **1.1 INTRODUCTION**

Recently much more attention has been devoted to coaching and supervision of cyclists, with much progress having been made in the fields of nutrition and training. With respect to training, the influence of biomechanical and aerodynamic research is gaining importance, as an increase in physical performance is the core around which the cyclist is attempting to reach his / her optimum ability. One goal is to reach a position on the bicycle, which is as efficient, comfortable and aerodynamic as possible. In order to achieve this correct position several issues need to be addressed: injury prevention, cadence, comfort (Burke and Pruitt, 2003), resistance, efficiency and power maximization.

(<http://bicyclefitting.com/English/Theory/PowerMax.aspx>).

Finding the optimum relationship between these areas and the factors that influence them is still a matter for research and much debate. Cyclists with more “slow twitch” muscle fibres opt for power; whereas those with more “fast twitch” muscle fibres are more likely to opt for suppleness and flexibility

(<http://bicyclefitting.com/English/Theory/PowerMax.aspx>).

In addition, events that require power, (e.g.: mountain biking) will see the cyclists adopting a higher saddle position that is recommended only for short term efforts, and which allows the use of heavier gears. The position often in the long term leads to more frequent complaints and injuries

(<http://bicyclefitting.com/English/Theory/PowerMax.aspx>).

Therefore performance maximization at the moment remains a matter of trial and error, with biomechanical elements as well as elements of injury prevention and physical training.

The result of research into power maximization has led to the development of the ellipsoid shaped chain-ring, the purpose of which was to increase the angle speed of the crank when it is at either the lowest point or the upper dead point, providing a constant chain speed. Research however has never been able to corroborate the effectiveness of the chain wheel in decreasing the moments in the pedaling cycle, and as a consequence they are no longer used in competitive cycling (<http://bicyclevfitting.com/English/Theory/PowerMax.aspx>).

As a result of the changing beliefs in bicycle theory, there are still numerous injuries that occur. These injuries have broadly been classified as, extrinsic (trauma) and intrinsic (overuse) injuries. Primary prevention is the preferred option for treatment of extrinsic injuries. Unfortunately, however, there is little research to help us identify the measures that could accomplish this prevention (Brown, 2002), as the factors that influence these types of injuries are often external to the activity of cycling (e.g. collision with a motor vehicle) and therefore cannot easily be controlled by the cyclist.

However, with respect to intrinsic injuries (overuse), the literature seems to indicate that there is a causal link between injury and:

- Incorrect bicycle set-up,
- Leg length differences,
- Types of materials used in bicycle frame,
- Material of the fork or shock,
- The type of pedal system used and
- What type of bicycle is used?

All of these are factors that can be controlled in part by the cyclist. This view is supported by Wilber et al. (1995), who found that 85% of cyclists report one or more overuse injuries at any one time, with 36% requiring medical treatment for such injuries.

Further to this, Kronisch *et al* (2002), suggest that although participation in cycling is more common among men, the risk of injury is greater for women.

According to Asplund, Webb and Barkdull (2005), improper bicycle fit, technique, or training patterns may cause or exacerbate these injuries, and can lead to dysfunction, impaired performance, and pain.

These links have not formally been researched and therefore the associations are, at best, anecdotal.

## **1.2 OBJECTIVES:**

**The first objective:** To investigate the injury profiles of South African cyclists, especially the profiles of mountain bicycle users on the road, as there appears to be no knowledge available on mountain bicycle use on the road.

**Hypothesis One:** the profile of injuries in cyclists in South Africa approximates the injury profiles in global literature.

**Hypothesis Two:** Injury profiles in cyclists riding mountain bicycles on road versus injuries in cyclists riding road bicycles on road should differ in the type of injury owing to the different type of bicycle and position on the bicycle.

**The second objective:** To see if there is an association between injuries and bicycle set-up in a South African context

**Hypothesis Three:** to determine whether there is a correlation between the type of injury that a cyclist presents and the bicycle set-up.

## **1.3 RATIONALE FOR THE STUDY**

1. To establish an injury profile in South African cyclists and its association to bicycle set-up.
2. Assist in furthering knowledge of prevention of primary, secondary and tertiary injury among cyclists.

3. Provide data on the association between bicycle type,(especially mountain bicycle) use on the road, as there appears to be no knowledge available on mountain bicycle use on the road, safety equipment and injury
4. Make recommendations for a future questionnaire for use in establishing more precise information about cycling specific injuries / bicycle related problems.

#### **1.4 LIMITATIONS OF THE STUDY:**

The study assumes that the data on the information sheet, as completed by the participant cyclists, are accurate and represent the exact happenings at the time of data input into the questionnaire. Other limitations include budget, time, the response and willingness of cyclists to attend visits in response to advertising.

#### **1.5 BENEFITS OF THE STUDY:**

1. To establish an injury profile in South African cyclists and its association to bicycle set up, especially with regard to mountain bicycle use on the road as there appears to be no knowledge available on mountain bicycle use on the road.
2. Assist in furthering knowledge of primary, secondary and tertiary injury prevention among cyclists, thereby helping Chiropractors to build on their knowledge, providing the patient with more effective health care in the future.
3. Make recommendations for a future questionnaire for use in establishing more precise cycling specific injuries / bicycle related problems.



## **CHAPTER TWO: LITERATURE REVIEW**

### **2.1. INCIDENCE OF BICYCLE RELATED INJURIES**

Pfeiffer and Kronisch (1995) claim that off-road bicycles (mountain bicycles) accounted for 62% of new bicycle sales in the United States. They are popular on both city streets and rough terrain. The number of mountain bicyclists increased from 200,000 in 1983 to 40 million in 1996. In a follow up study by Kronisch (1998), it was reported that, according to the National Off-Road Bicycle Association, mountain bicycles accounted for more than half of US bicycle sales in 1997.

Unfortunately, the number of injuries has increased just as quickly, with 600,000 visits to U.S. emergency rooms for bicycle related injuries, resulting in an average of 12-16 traumatic injuries / 100,000 person-miles and 13-14 overuse injuries / 100,000 person-miles ([www.birkenstock.com/health\\_wellness/sports/biking](http://www.birkenstock.com/health_wellness/sports/biking)). Thompson and Rivara (2001) go further to estimate that bicycle-related injuries account for approximately 900 deaths, 23000 hospital admissions, 580000 emergency department visits and more than 1,2 million physician visits per year in the United States, resulting in an estimated cost of more than \$8 billion annually ([http://medlib.med.utah.edu/WildernessMedicine/subman\\_ch3.htm](http://medlib.med.utah.edu/WildernessMedicine/subman_ch3.htm)).

According to the Traffic Safety Facts, National Center for Statistics and Analysis (NHTSA, U.S.A) cyclists represented nearly 2% of all traffic injuries in the US in 2003. Males represented 88% of all bicycle fatalities, with females representing only 12% of all bicycle fatalities in the US. Over 20% of cyclists who died in traffic accidents were aged 5-15 years, with cyclists representing nearly 1% of all traffic deaths ([www.wrongdiagnosis.com/lists/personal\\_injury.htm](http://www.wrongdiagnosis.com/lists/personal_injury.htm)).

The American Bureau of Transportation Statistics 2002 estimates that more than 49 million Americans ride bicycles at least monthly, with over 5 million people riding at least 20 days/month.

Thompson and Rivara (2001) found that the peak incidence of bicycle related injuries and fatalities is in the 9-15 year age group with a female to male ratio of 1:2-3. Other important risk factors include: the cyclist is male, between 9-14 years of age, cycling in summer, cycling in the late afternoon or early evening, not wearing a helmet, motor vehicle involved, unsafe riding environment; is from an unstable family environment; has a pre-existing psychiatric condition, is intoxicated, or is involved in competitive mountain-bicycle racing, (Thompson and Rivara 2001).

Therefore it would appear that there are numerous risk factors that predispose cyclists to injury, excluding deaths. These risk factors will be discussed in the following sections in relation to bicycle setup.

## **2.2 RISK FACTORS FOR INJURY**

When compared to other sports, cycling has a very low rate of injury per hour spent doing the activity (Brown 2002). This could be related to the fact that cycling is a low impact, non-weight-bearing activity (Sheets and Hochschuler, 1990), whereas running for example, makes the body carry its own weight and absorb the shock with each step taken. In cycling the weight is supported by the saddle, bars, and to some extent by the pedals (Coppolillo, 2000).

One needs however to consider the many risk factors that are associated with cycling (Brown 2002). First, there is the repetitive action of the cycling movement: even though a slight biomechanical flaw through one revolution is insignificant, multiplied by 5000 revolutions per hour the smallest point of weakness or misalignment can lead to dysfunction, pain and impaired performance (Holmes, Pruitt and Whalen, 1994). Second, there is a limited range of movement of the knees, ankles and especially the hip (which never moves into extension and uses less than 50% of its available range during a pedal revolution), as well as a prolonged static, flexed and relatively fixed posture that seems to increase the risk of injury especially lower back pain (Brown, 2002).

In order to understand the significance of these risk factors it is important first to have a general understanding of the bicycle set up.

## 2.3 AN OVERVIEW OF THE CURRENT LITERATURE RELATED TO CYCLING - BICYCLE ANATOMY



Figure 1: Drawing of the Components of the Bicycle (Bicycling, December 2005-permission obtained 16 November 2005)

Bicycles consist of many components (as seen in Figure 1) namely a frame, handlebars, brakes, wheels, pedals, gears, and other components in various configurations for the various modes of cycling (Mellion, 1991).

The key part of the bicycle is the frame, made of various metals or metal alloys such as titanium, aluminum, steel, or carbon (Asplund and St Pierre, 2004). Essentially, the frame consists of two triangles (combined to form a diamond shape / traditional frame design), (Mellion, 1991), the front triangle consists of the top tube, the seat tube, and the down tube, and the rear triangle consists of the chain stay, seat stay, and seat tube.

Handling and maneuverability of the bicycle can be affected by the angles within each of these triangles.

Racing bicycles have a more upright geometry, with steeper angles for increased maneuverability, whereas touring bicycles have a flatter geometry for comfort and are thus more stable (Asplund and St Pierre, 2004). Mountain bikes have an even flatter geometry that is designed to absorb the shock of rough road surfaces and single-track terrain (Mellion, 1991).

In addition to this the drive train consists of: the crank arms, chain rings, chain, gears, and derailleurs that transfer cyclists' energy into mechanical propulsive energy. The shoe-pedal interface is vital to this energy transfer, therefore cycling shoes clip directly into the pedals (Asplund and St Pierre, 2004), linking the rider directly to the bicycle and allowing for the energy system not to be interrupted.

The ultimate goal of the drive train is to allow a pedal stroke that is a continuous, smooth and circular movement in which minimal energy is lost. In this respect, the ultimate aim in movement can be affected and controlled by gearing, which allows the cyclist to overcome resistance whilst cycling and pedal more comfortably at a uniform cadence to improve pedaling efficiency. Therefore, utilizing the bigger gears results in higher resistance while lower gearing provides less resistance and therefore greater efficiency. This provides the cyclist with options for optimal cycling efficiency as and when required during a cycling event (Asplund and St. Pierre, 2004).

### **Road racing bicycle**

The most important angle on a road racing bicycle is the seat tube angle, the angle between the seat tube and the ground, which is designed to have the knee over the pedal spindle (KOPS) with the forefoot on the pedals and the crank arms horizontal to the ground. Most road bicycle frames have an angle of 72°-74° which allows the average cyclist's knee to conform to the KOPS system, resulting in only minor adjustments to the fore and aft position of the saddle. As a result the seat tube angle relates to the cyclist's femur length. The longer the femur, the shallower the angle becomes because a shallower angle moves the cyclist back on the bicycle. Consequently a cyclist with a short femur would have to have a steeper seat tube angle to position the knee far enough forward.

However, the steeper the seat tube angle, the harsher the ride, which limits bicycle usage to shorter cycling events only (Burke and Pruitt, 2003).

Head tube angle is based on frame size, top tube length, seat tube angle, pedal clearance in relation to the front wheel and steering characteristics. Head tube angle is normally between  $73^{\circ}$  -  $75^{\circ}$ , which allows for decreased frame flex and a decreased tendency for the bicycle to stray when descending a hill or while riding on straight sections of road. A shorter wheelbase also increases the receptiveness of the steering. Therefore the cyclist should always select a frame that affords a mix between comfort and handling. A smaller frame is not only lighter and stronger but also handles better (Burke and Pruitt, 2003).

Desirable Seat tube length, which equates to frame size on a conventional frame, can roughly be obtained while standing on the floor in ones socks and taking the measurement from the floor to the cyclist's pubic bone. An average of 66% of this measurement would allow an accurate approximation of the seat tube length. This should be comparable with the actual bicycle seat tube length, which is traditionally measured from the centre of the bottom bracket to the centre of the lug at the top of the seat tube. However some manufacturers measure from the top of the lug to the seat tube (Burke and Pruitt, 2003).

A compact frame, with a sloping top tube allows for a smaller, stiffer frame, which is a popular design for mountain cyclists. To obtain the size of a compact frame one measures from the centre of the bottom bracket in an upward vertical line to a point which, on a traditional road frame, would intersect the top tube that extends horizontally from the head tube to the seat tube (Burke and Pruitt, 2003).

## **Mountain bicycles**

As in road bicycles, mountain bicycles sizes are also determined by seat tube length, however, the clearance between the crotch and the top tube when the cyclist straddles the top tube in cycling shoes should be a minimum of 75mm compared to a road bicycle that can only have about 25 mm (Mellion 1991). Mountain bicycles' seat tube angles are around 71°-73° (Burke and Pruitt, 2003).

Though road frames are measured from the centre of the crank spindle to the centre of the top tube; mountain bicycle frames are normally measured from the centre of the crank spindle to the top of the top tube (Burke and Pruitt, 2003). To measure a bicycle with a sloping top tube, measurement is taken from the top of where it would be if it were level with the horizon (Burke and Pruitt, 2003).

Most racing cyclists will have a similar position relative to saddle height for both their mountain and road bicycles, which is an attempt to reduce the risk of injury. Most mountain bicycles have longer crank arms than do road bicycles, therefore one should lower the saddle to equal the difference in crank length, necessary to give the correct amount of bend in the knee at the bottom of the pedal stroke (for example, if 170mm cranks are used on a road bicycle and 175mm on a mountain bicycle then the saddle of the mountain bicycle should be lowered by 5mm) (Burke and Pruitt, 2003).

Different bicycles are designed to position the rider differently, touring bikes allow for an upright ride, with less flexion placed on the back, while racing and mountain bikes focus on the need for a more stream-lined ride thus the rider has to extend the neck more. These differences impact what type of pain the rider experiences.

## 2.4 CORRECT BICYCLE SET-UP OR FIT

Over the years, several formulas have been developed through the use of the metabolic or empirical data to set saddle height for cyclists.

In this regard it is thought that when fitting the bicycle to the cyclist, the cyclist must always wear the shoes that he or she wears while cycling, as this provides for proper fit and comfort while riding (Burke and Pruitt, 2003). Thus, according to Pruitt, "cycling is a marriage between the somewhat adaptable human body and a somewhat adjustable machine, the goal being to adjust the bicycle to the cyclist so that the cyclist has to adapt as little as possible" (Burke and Pruitt, 2003).

Harris (2003), believes that when it comes to set up there is no magic formula that includes each and every cyclist and suggests that the ideal fit changes as one rides more mileage and increases ones flexibility, or as one gets older and less flexible.

However in order to address the context of bicycle set up, one needs to understand the interaction between the bicycle and the cyclist.

### Frame size

Frame size is determined by the seat tube dimension measured along the seat tube in one of two ways (<http://www.coloradocyclist.com/bicyclefit/>):

- i) Centre-to-top (C-T) or
- ii) Centre-to-centre (C-C).

C-T is the distance from the centre of the bottom bracket to the top of the top tube or seat lug. C-C measures from the centre of the bottom bracket to the centre of the top tube. To size your C-T road frame take your inseam measurement and multiply it by 0.67 (Inseam in cm x 0.67). The C-C, known as the LeMond formula, is calculated by taking the inseam measurement and multiplying it by 0.65 (inseam in cm x 0.65), which yields virtually the same frame size when you add the 1.5 cm difference between C-C and C-T. (<http://www.coloradocyclist.com/bicyclefit/>). Table 2.1. below refers bicycle sizing to rider height.

Table 2.1: Road bicycle sizing. (Adapted from <http://www.giant-bicycles.com/us/050.000.000/050.600.100.aspx>)

Rider height (cm)	Conventional frame sizing (cm)	Compact frame sizing	Seat tube/Tube length (cm)
1,5-1.57	49-51	Extra small	44/52
1.57-1.67	51-55	Small	45/53
1.67-1.80	55-59	Medium	50/55.5
1.80-1.90	59-63	Large	55.5/58.5
1.90-200	63-67	Extra Large	58.5/61

Men have proportionally shorter legs than women, thus a women's frame and seat height will usually be higher than that of a man of the same height (<http://www.bicyclingsource.com/bike-fitting>).

Burke and Pruitt (2003), believe that cyclists interested in performance and comfort require a properly fitted bicycle, as a correctly fitted cyclist will be efficient, powerful, comfortable, and injury free on the bicycle.

An efficient and powerful position enables the cyclist to pedal effectively without wasting energy on improper pedaling mechanics. Comfort on the bicycle is dictated by the cyclist's weight being distributed equally between the handlebars, saddle and pedals so the skeletal system bears the weight instead of the muscles of the back and arms.



In addition a good bicycle fit, is imperative not only for comfort but also for minimizing potential for injury. Improper position can lead to overuse injuries and premature fatigue while riding. Too small a frame forces the cyclist to lean over too far as the bars will be far below the saddle. Too large a frame will cause the rider to stretch out too far (Burke and Pruitt, 2003)

### **Optimal saddle height**

According to Mellion (1991) there are several scientific and quasi-scientific methods for determining the seat height of a bicycle.

**Method one**. The simplest and quickest way to determine seat height is to have the cyclist connect his or her bicycle to a trainer, climb on the bicycle and pedal until comfortable. Get the cyclist to unclip his or her feet, place their heels on top of the pedal and then pedal backwards. The saddle height should be set at a height where the heels are still in contact with the pedals, without the hips rocking from side to side, as the cyclist reaches the bottom of his or her pedal stroke (Burke and Pruitt, 2003). This yields a position that will be slightly lower than the other formulas that follow below.

**Method two**. The cyclist stands against a wall wearing cycling shoes with the feet about 15 cm apart on a hard floor and holds a book in a horizontal position while pulling it up between the legs. Measure the distance from the floor to the crotch and then multiply that measurement by 1.09 (<http://www.coloradocyclist.com/bicyclefit/>).

This is the distance from the centre of the pedal spindle to the top of the saddle when the crank arm is parallel to the seat tube, giving you the upper limit to saddle height (See Figure 2, size 1)

(<http://bicycling.com/English/Theory/SaddleHeight.aspx> and (Burke and Pruitt, 2003)

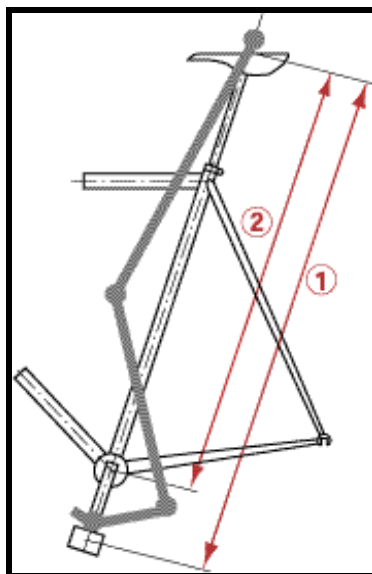

Figure 2: Optimal Saddle Height using Method Two

Adapted from: (<http://bicyclefitting.com/English/Theory/SaddleHeight.aspx>)

**Method three.** As recommended by LeMond (LeMond and Gordis (1987), multiply the inseam measurement by 0.883 to get the distance from the centre of the bottom bracket to the top of the saddle (See Figure 2, size 2) (<http://bicyclefitting.com/English/Theory/SaddleHeight.aspx>). This works out to be 0.6 – 25mm lower than the first method. There are however five qualifiers to this formula (Burke and Pruitt, 2003).

- 1) This method was developed in the early 1980s when cycling shoes had thicker soles and the pedals had toe clips, which position the foot higher than modern clipless pedals do. The 0,883 multiplier may be too high for the modern equipment; still it provides a good starting point.
- 2) Cyclists with long feet for their height may find this formula sets the saddle too low.
- 3) Always take into consideration that some cyclists have excessive soft tissue over their Ischial tuberosities, which compresses after sitting for a while.
- 4) Orthotics added into the shoe have the effect of lengthening the legs.
- 5) Thicker padded shorts effectively shorten the legs and so the cyclist may require a lower saddle.

**Method four.** Holmes et al., (1994) supported by Souza (1996) believe that the correct saddle height for a cyclist with no knee pain allows for between 25-30° of knee flexion when the leg is extended and the pedal is at bottom dead centre, as seen in Figure 3.



Figure 3: Demonstration of Optimal Saddle Height Using Method Four  
Adapted from (<http://bicyclefitting.com/English/Theory/SaddleHeight.aspx>)

This angle of 25°-30° is formed by the greater femoral trochanter to the lateral condyle of the femur, to the lateral malleolus of the extended leg. It has been indicated in the literature that flexion of 25°-30° allows for adequate decompression of the knee thus preventing anterior knee injuries, by decreasing anterior knee stress. This reduces patellar compression, and also avoids the dead spot of the pedal stroke (Burke and Pruitt, 2003)

All the above formulas are estimates to achieve a starting point of cyclist evaluation, (Mellion 1991). Harris, (2003) recommends that any additional adjustments must occur over time with no more than 3 mm change at any one time, while Mellion (1991), suggests small increments of approximately 6 mm every three training rides. A mountain bicycle's saddle height should be the same as the cyclist's road bicycle or only slightly lower because a mountain bicycle has a higher bottom bracket. The same position on a mountain bicycle may result in a centre of gravity that is too high. The slightly lower position allows for better stability with a minimal cost to efficiency (Burke, 1994).

Harris (2003) supports Burke (1994) in saying that these formulas provide good starting points but shoe / cleat thickness, foot size, pedaling style, and other factors also come into play.

The best approach is to raise the saddle in small increments at a time until one's optimum height is reached with little to no rocking in the hips.

### **Upper body position.**

Reach is defined by Mellion (1991) as the distance from the saddle to the transverse part of the handle bar, normally adjusted according:

- To cyclist comfort;
- To the level of the cyclists back conditioning; and
- To the position that can be maintained during varied distances on the bicycle.

To obtain the correct reach the cyclists should sit on the bicycle with the arms bent slightly ( $15^\circ$ ), the hands on the drops, facing forward. Drop a plumb line from the tip of the cyclists' nose. It should bisect the handle bar in the centre at the stem. Some determine stem length where the transverse part of the handlebar blocks the view of the front axle.

Lemond (1987) recommends a position where the elbow and knee are separated by 2.5cm to 5 cm, while the cyclist is in the drops with the arms bent at a  $65^\circ$ - $70^\circ$  angle.

### **Top tube and stem length.**

Top tube length on conventional frames is defined as the horizontal distance from the centre line of the head tube to the centre of the seat tube, as seen in Figure 4 below. On bicycles with a sloping top tube (compact frames and mountain bicycles) this is a theoretical number, measured horizontally from the centre of the head tube at the height of the top tube to the centre of the seat post.

([http://www.billbostoncycles.com/top\\_tube\\_length.htm](http://www.billbostoncycles.com/top_tube_length.htm)). "Ideal position" varies here more than anywhere else for cyclists, depending on riding style, flexibility, body proportions, and frame geometry, among others.

Unfortunately, there is no set formula for sizing the top tube and stem. The top tube length contributes to the distance from the seat to the handlebars, and therefore should vary with the rider's size. Both arm length and torso length figure into the proper distance from seat to handlebars (Asplund, Webb and Barkdull, 2005). Firth (2005) recommends that top tube length can be calculated as being two thirds of the inseam measurement e.g.: inseam =84cm then top tube will be 56cm.

Once the hip and hand position have been established, the top tube must be long enough to allow for good breathing and short enough to prevent excessive bending of the lower back. Additionally, the shoulder angle should never exceed 90°, as the upper body weight is not supported properly by the skeletal structure. If this occurs it leads to shoulder and upper back complaints and fatigue

([http://www.billbostoncycles.com/top\\_tube\\_length.htm](http://www.billbostoncycles.com/top_tube_length.htm)).

Top tube and stem lengths affect the reach of the rider, or horizontal fit, and are also an important measurement for proper frame fit. Stems should be between 90-120mm; outside this range the top tube may be the incorrect size (Harris, 2003).

Asplund et.al (2005) state that a stem shorter than 40mm or longer than 140mm alters the stability of the bicycle, so it is important that the top tube length be as close to correct as possible. Women have shorter arms in comparison to men of the same height, therefore should have a shorter stem than does a man of equal height (<http://www.bicyclingsource.com/bike-fitting>). Proper reach allows for better comfort, weight distribution and handling. The problem is that the ideal position varies considerably, depending on: frame geometry; cycling style; flexibility; and body position, among others. In addition upper body position evolves with more hours in the saddle, developing a lower, longer position as fitness and flexibility improves. One indicator allows the handlebars to be set in a position so that the nose is directly above the handlebars when down on the hooks of the handlebar (<http://www.bicyclingsource.com/bike-fitting>).

With your hands on the drops there should be between 2,5 and 5 cm between your knees and elbow, when the elbows are bent at 65°-70°

([www.coloradocyclist.com/bikefit/](http://www.coloradocyclist.com/bikefit/) How to fit Your Custom Bicycle accessed 1/14/05)

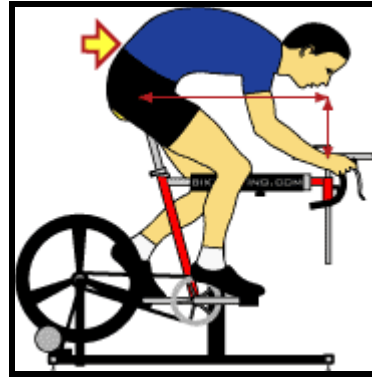

Figure 4: Demonstration of Top Tube Length & Reach

Adapted from (<http://bicyclefitting.com/English/Theory/LowerBack.aspx>)

### **Handle bar position and size.**

On road bicycles the bottom of the handlebar should be level or angled down slightly toward the rear hub. The brake levers should be positioned that when a straight edge is extended forward from under the handle bar, the brake lever tip just touches (see Figure 5, bottom right picture).

The best all round riding position is with the hands on top of the brake hoods as this allows for good steering, quick brake access and good grip when climbing out of the saddle (Figure 5, bottom left picture). In both road and mountain bicycles the optimum position is to try to keep the wrists straight with minimal cocking of the wrist if possible. (Figure 5 bottom pictures and figure 6-left picture).

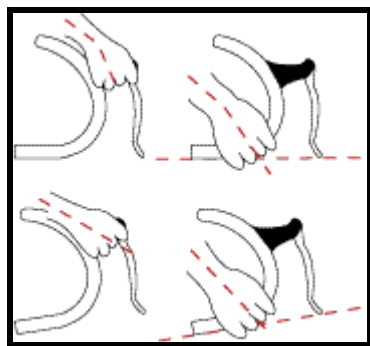

Figure 5: Road Bicycle Handle Bar Position

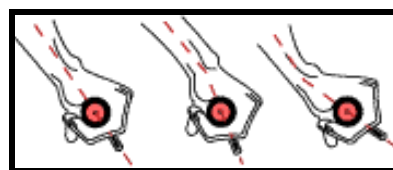

Figure 6: Mountain Bicycle Handle Bar Position

Figure 5 and 6 adapted from (<http://bicyclefitting.com/English/Theory/Comfort.aspx>)

If a cyclist has one arm that is longer than the other, the one brake lever should be slightly higher, as the short arm will have a higher brake lever. Normally an asymmetrical reach results in pain being felt as a stabbing pain in the one shoulder or on one side of the neck (<http://www.coloradocyclist.com/bicyclefit/>)

Road bicycle handlebars come in several widths and bends, while mountain bicycle bars range from the traditional flat bars to the riser bars. Most cyclists select a handlebar that is the width of their shoulders, measured as the distance between the shoulders, or from the Acromion to the Acromion (between the shoulder joints) (<http://www.coloradocyclist.com/bicyclefit/>). On better-designed mountain bikes the handlebars are much lower than the seat, and are far enough forward to promote the optimal 45-degree back posture (<http://www.bicyclingsource.com/bike-fitting>).

If the handlebars are too wide this increases the frontal surface area of the cyclist and leads to greater air resistance. An additional disadvantage is that the cyclist will develop complaints in the neck and shoulders due to sagging between the shoulder blades. Too narrow handlebars will result in a loss of oxygen intake and nervous steering (<http://bicyclefitting.com/English/Theory/Comfort.aspx>).

The height of the handlebars should be 2.5-5cm lower than the top of the saddle for a short cyclist and up to 10cm lower in the larger or flexible cyclist. If a cyclist is complaining of cyclist palsy (hand numbness-compression of the Ulnar or medial nerve) or pain in the neck, arms or shoulders, raise the stem to take the weight off the hands. The width of the bars should coincide with the width of the shoulders, measured from the one Acromion to the other across the front of the chest (Souza, 1996). Handlebars that are too wide may cause excessive trapezius and rhomboid strain leading to muscle spasm and pain (Burke, 1994). Wide handlebars are best for slow speed control, whereas narrow bars are better for quicker turning. In addition cyclists with tight hamstrings or low back pain require a shorter stem and a normal to low saddle height (Burke and Pruitt, 2003).

Harris (2003) believes that cyclists need to try to achieve the proper weight distribution between the front and the rear wheels; ideally 45% at the front and 55% at the back. Coppolillo (2000) recommends 40% of the body weight on the handlebars. When there is too much weight forward, bicycle control, handling, and safety may become a problem, especially when descending. The chance of hand numbness, tired arms and shoulders, as well as neck, shoulder and upper back pain is increased. Too much weight on the rear wheel results in handling problems, especially front-end shimmy on descents (Firth, 2005).

In mountain bicycles, the upper body is more extended allowing enough room with no overlap of the knees and elbows. The top of the stem should ideally be 2.5-5cm below the top of the saddle. Too high will result in the cyclist's centre of gravity being raised and unevenly distributed. Too small a frame forces the cyclist to lean over too much, making the cyclist lean over the bars. Too large a frame stretches the cyclist too far out resulting in thoracic pain (Burke and Pruitt, 2003).

Brown (2005) recommends that ideal handlebar height in relation to the saddle height is a function of the intensity with which the cyclist pedals. If the handlebars are too low, increased Lordosis of the lumbar spine and increased hyperextension of the cervical spine occur, leading to both low back and neck pain (Lemond and Gordis, 1987).



Handlebar height will vary as the condition of the cyclist varies, for instance at the beginning of the season the cyclist will be more comfortable on slightly raised handlebars and as the season and fitness progress, then bars can be lowered. A cyclist who pedals all the time will be more comfortable with lower handlebars than the cyclist who coasts down hill.

### **Fore and aft saddle position.**

With the cranks horizontal to the ground (three o'clock and nine o'clock position), a straight edge or a plumb line is dropped from the front of the patella of the forward knee down to the end of the crank arm.

The patella should bisect the pedal spindle, allowing for the centre of rotation of the knee to be located over the centre of the rotation of the pedal, resulting in a good starting point for proper weight distribution (Coppolillo, 2000). Moving the saddle back allows for a lower posture, which is more aerodynamically efficient, allowing the use of all the leg muscles while at the same time being better for the back and breathing.

Moving the saddle farther back also allows more 'ankling' which is more conducive to longer endurance type of events. The more forward the saddle position, the more power is available, hence the steep seat tube angle on racing and sprinting bikes (<http://www.bicyclingsource.com/bike-fitting>). Coppolillo (2000) states that it must be remembered that every time the saddle is moved forward, saddle height is effectively being lowered and vice versa. Exceptions to the above position are seen with road cyclists that push big gears, where they sit further back behind the bottom bracket. This however has been reported to result in low back pain or hamstring problems, and should only be used for a cyclist with long femurs coupled with good core stabilizers and a flexible lower back (Burke and Pruitt, 2003)

## Saddle tilt.

The saddle should be level or with a slightly elevated front-end. Women seem to prefer a saddle with a slightly angled front of the saddle, preventing pressure on the Perineal region (Figure 7, green & red dotted line).

Nose up in men results in urological and neuropathic problems with implications for the lower back as the normal curve of the spine is changed.

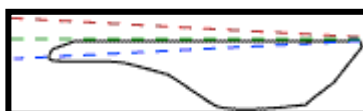

Figure 7: Saddle Tilt (<http://bicyclefitting.com/English/Theory/Comfort.aspx>)

There are however two exceptions to the rule: (Burke and Pruitt, 2003)

- 1) Cyclists with unusual pelvic tilts or lumbar postures may require a slight upward tilt so more weight is placed on their Ischial tuberosities. Consider raising the handlebars as that may allow one to level the saddle and still get the pressure off the Pudendal nerve.
- 2) Some time trial cyclists drop the nose for a lower position in conjunction with aero bars.

## Crank arm length (as seen in Figure 8)

Crank arm length determines the size of the pedal circle, which effectively relates to the vertical distance the cyclist's feet rise from the bottom of each pedal stroke to the top.



Figure 8: Crank Arm Length (<http://bicyclefitting.com/English?Theory/Crank.aspx>)

If a short cyclist uses long cranks, the hips and the knees have to flex uncomfortably at the top of the pedal stroke, resulting in complaints in the knees and hips. Crank length influences the leverage and revolutions per minute (rpm) that a cyclist produces while cycling.

Long crank arms are used for pushing large gears and climbing at low rpm while shorter cranks are good for low gears and high rpm pedaling (Burke and Pruitt, 2003).

Mountain bicycles generally have cranks that are 2,5 to 5 mm longer than those on a road bicycle (<http://www.coloradocyclist.com/bicyclefit/>). It must therefore be noted that if crank arms are changed one needs to adjust the seat height accordingly. Crank lengths can be determined using the two different principles as seen in Table 2.2 and Table 2.3.

Leg Length/Inseam length	Crank Length	Crank length (mm)	Height (m)
60 to 65cm	150mm	160.0	<1.52
66 to 70cm	155mm	165.0-167.5	>1.52-<1.68
72 to 75cm	160mm	170.0	>1.68-<1.83
75 to 78cm	162.5mm	172.5	>1.83-<1.89
79 to 81cm	165mm	175.0	>1.89-<1.95
82 to 83cm	167.5mm	180.0-185.0	>1.95
83 to 86cm	170mm to 172.5mm		
87 to 90cm	175mm to 177.5mm		
91 to 94cm	180mm		
94cm plus	185mm		

Table 2.2 (Left): Crank Length according to Leg Length/Inseam Length ([www.Check your Cranks.htm](http://www.Check your Cranks.htm)).

Table 2.3 (right): Crank length-using height as a determinant (Burke, 1996)

### Foot position.

The position of the feet should be such that the ball of the foot is directly over the pedal axle (as seen in Figure 9, below). In order to prevent knee pain, adjust the cleats so the angle of the foot on the pedal is neutral, and as close to the cyclist's own natural position on the pedal. Sometimes cyclists mount their cleats on their shoes so the ball of the foot is ahead of or behind the pedal axle. If the ball of the foot is ahead of the axle, the effective lever arm from the ankle to the pedal is shortened, requiring less force to stabilize the foot on the pedal and decreases the strain on the Achilles tendon and calf.

If doing this, the cyclist must adjust both feet and remember to lower the saddle. Shoe size is also important, as cyclists with a shoe size of 9 and smaller should move the ball of the foot behind the pedal axle. Those with a shoe size larger than 11 should consider moving the ball of the foot slightly in front of the pedal axle. Cyclists with numbness in the foot can benefit by sliding their cleats all the way back, putting the ball of the foot as far forward as possible thus minimizing direct pedal pressure (Burke and Pruitt, 2003).

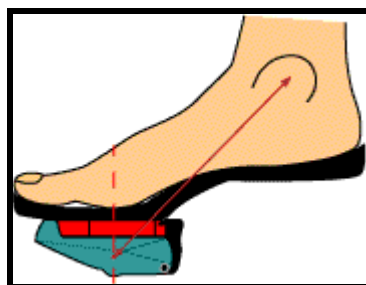

Figure 9: Diagram showing correct foot position:  
(<http://bicyclefitting.com/English/Theory/FootPosition.aspx>)

### **Optimal pedal cadence.**

Much of the research on optimal cadence has produced conflicting results. The optimal cadence for gross efficiency expressed as work performed/energy cost is 60–80 revolutions per minute (rpm) for moderate to high workloads. Efficiency falls off at greater than 100 rpm.

Higher gear ratios result in higher pedal resistance and in order to ride safely require well-developed strength, endurance and better technique. Lower gear ratios result in lower pedal resistance and permits pedaling or “spinning” at higher cadence. Overuse injuries are apparently less common when using lower gear ratios at a higher cadence (Mellion 1991).

## **2.5 INJURIES TO CYCLISTS**

Injuries are classified as either extrinsic (trauma) or intrinsic (overuse) injuries (Brown, G. 2002). Most bicycling related extrinsic injuries occur to the upper or lower extremities, followed by the head, face, abdomen or thorax, and then the neck. These normally involve superficial trauma such as abrasion (“road rash”), contusions and lacerations (Thompson and Rivara, 2001).

Bicycling related intrinsic injuries arise from chronic overload or micro-traumatic problems, occurring over a period of time when a force is applied to a structure and therefore increased faster than the structure can adapt. Repetitive activity fatigues a specific structure, such as tendon or bone. Without adequate recovery, micro trauma stimulates an inflammatory response, releasing vasoactive substances, inflammatory cells, and enzymes that damage local tissue. Over time, this trauma leads to clinical injury. Continued activity produces degenerative changes that result in weakness, loss of flexibility, and chronic pain. Thus, in overuse injuries, the problem is often not acute tissue inflammation (tendonitis), but chronic degeneration, or tendinosis (Khan *et al.* 2000).

According to Bergmann (1993) all viscoelastic structures, exhibit a phenomenon called hysteresis, which is a loss of energy, either absorption or dissipation of energy when viscoelastic structures are subjected to repetitive loads. The larger the load, the larger the hysteresis, but when the load is applied for the second time, the hysteresis decreases, which implies that these viscoelastic structures are less protected against repetitive loads. Creep, on the other hand is the progressive deformation of a structure under constant load (Bergmann *et al*, 1993). Causes of overuse injuries in cyclists include the following.

- Training error. The most common cause of training errors includes: too many miles too soon; excessive hill or speed work, and the very common cyclist who pushes too-big gears (riding in too big a gear for the terrain), (Brown, 2002).
- Incorrect position on the bicycle. This includes problems in the knees (due to a saddle that is too high or low, too far forward or backward; cranks that are too long, too close together or too far apart, a bent pedal axle, cleat position, or limited degree of cleat float), (Brown, 2002).
- Unusual body type. Body type problems include leg length discrepancies; a wide pelvis placing the knees further apart and stressing the outside of the knee; excessive foot pronation (flat footed) associated with medial (inside) knee pain; rotation of the tibia (shin bone); and imbalanced muscles leading to maltracking of the patella (knee-cap),(Brown, 2002).
- Off the bicycle activities. These include, running on hills, deep squats and leg presses which can precipitate knee and or shin pain. (Brown, 2002)

Burke and Newson (1988) believe that pathomechanical cycling injuries can be defined as overuse injuries that stem from the incompatibilities between the cyclist and the bicycle. Injuries result from differences between fixed motion patterns of the drive mechanism of a bicycle and the complex anatomical movement patterns of the human body. A cyclist who suffers from early signs of pathomechanical overuse injury, such as low back pain, has three roads to recovery. First, eliminate the repetitive stress by resting, but in most cases, rest is unacceptable to cyclists.

Second, make mechanically acceptable adjustments to the bicycle so as to function within the constraints of the cyclist's anatomy.

Finally, and most relevant to the clinician, for recovery from pathomechanical overuse injuries, make anatomically acceptable changes in the human body (stretching) so that the rider can conform to the motion pattern involved in cycling.

It is critically important that these factors be understood and addressed when treating overuse injuries in cyclists (Holmes *et.al*, 1994). In congruence with these assertions, Wilber et al. (1995) in a mail questionnaire study of over 500 recreational cyclists, indicate that 85 % of cyclists reported one or more overuse injuries, with 36 % requiring medical treatment.

Burke (1994) therefore believes it is imperative for cyclists to ensure that their bicycle saddle, handlebars and pedals are correctly adjusted and their bicycle is the correct size to prevent overuse syndromes.

## **2.6 MOST COMMON ANATOMICAL SITES FOR OVERUSE INJURY / COMPLAINTS**

The most common anatomical sites for overuse injury / complaints reported by male and female cyclists combined were neck (48,8%), followed by the knees (41,7%), groin / buttock (36,1%), hands (31,1%) and back (30,3%) (Wilber et al, 1995). For the male cyclist, the effects upon back and groin / buttock overuse injuries were miles per week, lower number of gears used and few years of cycling. For female cyclists, training characteristics which had the most significant effect upon groin / buttocks. Overuse injuries, were found more in non-competitive events per year and associated with less stretching before cycling. The odds of female cyclists developing neck and shoulder overuse injuries were 1,5 – 2 times higher than for their male counter parts (Wilber et.al, 1995). Overuse injuries tend to affect tendons, muscles, fasciae, bursas and even nerves.

**Tendons.**

Tendonitis is due to inflammation resulting in mild pain. Crepitus (crackling) results from an accumulation of fluid, which can sometimes remain undetected.

As time goes on more long standing tendon problems result in degenerative changes within the tendon and begin to contribute more and more to the pain.

At this point the condition becomes known as tendinosis. Due to the complex tissue breakdown, these conditions are grouped under the term "Tendinopathies" (Khan et al.2000).

According to Brown (2002) tendinopathies are known to be associated with the use of performance enhancing drugs, for example anabolic steroids. The overall effect is that muscle strength develops more rapidly than the tendon has a chance to adapt and to the increased loading, results in damage to the tendons.

**Muscles and Fasciae.**

Muscle and fasciae injuries result from conditions of neuromuscular dysfunction.

As the muscle is required to shorten many times it starts to fatigue, becomes painful, and cramps resulting in sensory disturbances. The affected muscles have trigger points that can result in pain some distance away (Simons, Travell and Simons, 1999).

Biomechanical imbalances can cause muscle and fascia problems, which often affect the spine, resulting in a phenomenon referred to as a spinal segmental dysfunction (Brown, 2002). This often results in a decreased range of motion at the lumbar 2/3 and 3/4 vertebral segments, causing backache alone or with thigh pain referring to the knee, or both.



**Bursae.**

Bursa are structures that form between joint surfaces or in regions where the surfaces move over one another which can include tendons, bones or muscles, which act to reduce friction between the moving parts. Irritation or inflammation of the bursa is known as bursitis. Often when in close proximity to tendons the patient presents with signs and symptoms similar to tendonitis, for example Ilio-tibial band syndrome (I.T.B.) (Brown, 2002).

**Nerves.**

Compression neuropathy is a disorder of peripheral nerve function. In cyclists the most common compression neuropathy is ulna neuropathy, which results from pressure on the inside of the wrist (too much weight on the handle bars) and in men, Pudendal nerve pressure resulting in a numb penis is a common condition (Brown, 2002).

**Hand problems.**

Incorrectly adjusted handlebars often cause complaints in the hands and wrist. If the difference in height between saddle and the handlebars is too large a major proportion of the body weight ends up over the handlebars (<http://www.bicyclefitting.com/English/FAQ/HandWrist.html>). As a result hand problems can be divided into compression syndromes and overuse syndromes. Ulnar nerve lesions are the most reported of the compression type syndromes, with the median nerve second.

Ulnar nerve compression produces symptoms of sensory changes and weakness, a condition that was recognized as far back as 1869, which has become known as cyclists palsy (Reid, 1992). Compression of the ulnar nerve is a common problem for competitive and recreational cycle enthusiasts, alike. Compression is the result of direct pressure on the ulnar nerve from the grip on the handlebars.

Often, the nerve may be stretched or hyper-extended when a drop-down handlebar is held in the lower position (Rehak, 2005). The pathology is due to pressure on the ulnar nerve as it passes into the hand through the Pisohamate, or Guyon's canal (Reid, 1992).

Median nerve entrapment at the wrist (Carpal Tunnel syndrome) was first described by Sir James Paget in 1854 (Reid, 1992). Clinically cyclists can present with any of the 4 stages of carpal tunnel syndrome.

- Stage 1: Uncharacteristic discomfort in the hand, no precise localization to the median nerve
- Stage 2: Symptoms localized to the area supplied by the median nerve.
- Stage 3: Impairment of digital function, complaints of clumsiness.
- Stage 4: Sensory loss in median nerve distribution, wasting of the Thenar eminence.

The most common overuse syndrome is De Quervain's Tenosynovitis, originally described by deQuervain in 1895 (Reid, 1992), which involves an inflammation of the tendons of the first dorsal compartment of the wrist (viz. the abductor Pollicus Longus and the Extensor Pollicus Brevis). Presentation includes pain along the tendons, with palpation eliciting tenderness and on occasions crepitation.

All movements of the thumb are usually uncomfortable, the most dramatic clinical sign being Finkelstein's test (Magee, 1997). Many individuals will complain of difficulty when grasping objects firmly (Reid, 1992) and cyclists have difficulty braking and grasping the handlebars.

On the bicycle take the pressure off the medial aspect of the hand, adjust the handle bar position, and use thicker bar tape or thicker padded gloves. The padding absorbs the shocks and jolts from the road, limiting the stress transmitted to the hands (Coppolillo, 2000). Sit in a more upright position, taking the weight and pressure off the hands and wrists.

Take a rest during long rides and change hand position on the handlebars often. Shift weight from the center of the palms to the outside edge of the palms as often as possible (Rehak, 2005).

Mountain bicyclers should set up their fork to as soft a setting as possible to absorb the bumps. Try using a bicycle with a shorter top tube, moving the saddle back a little and ensuring that it is not tilting downward (Brown, 2002).

### **Neck pain**

Neck pain is caused by the extra tension developed in the muscles of the shoulder, neck and upper spine that are used to keep the neck in a hyper-extended position (Simons, Travell and Simons, 1999) and the back flexed for prolonged periods. Riding in drop handlebars for long periods increases the load on the arms and shoulders as well as hyperextension of the neck, leading to muscle fatigue and pain. If the virtual top tube length (top tube plus stem length) is too long for the rider, or if aero bars are used, hyperextension of the neck is further increased.

Prolonged hyperextension of the neck and associated muscle strain may lead to trigger points in the muscles of the neck and upper back (Asplund, Webb and Barkdull, 2005). The jarring and vibration whilst cycling, can further aggravate this problem (Simons, Travell and Simons, 1999) especially when riding with hard tyres.

Myofascial (muscle) pain is very common, because trigger points become active as a result of prolonged isometric contraction of the muscles, aggravated by emotional stress, cold and fatigue (Simons, Travell and Simons, 1999). Isometric contractions restrict blood flow to the area of contraction, leading to an ischemic response that may cause muscular spasm and therefore increased pain. In addition metabolic waste products may accumulate in the muscles and lead to pain (Sheets and Hochschuler, 1990).

Thoracic Outlet syndrome (TOS), a condition that is a collection of symptoms, is defined as a “compression of brachial plexus and Subclavein vessels by muscles attached in the region of the first rib and clavicle“ (Simons, Travell and Simons, 1999). This condition results in posture related aching in the arm, a variety of sensation changes and vascular compromise resulting in cold hands.

TOS is most often produced by hyperextension neck injuries, typically traumatic, but may also be caused by repetitive over hyperextension of the neck (Asplund, Webb and Barkdull, 2005).

Aching between the shoulder blades is usually due to stiffness and dysfunction in the upper thoracic spine

(<http://www.bicyclefitting.com/English/FAQ/NeckShoulder.html>).

Cyclists with scoliosis (lateral curving of the spine) often experience complaints of the neck and shoulders when bending the upper part of their body in their cycling position (<http://www.bicyclefitting.com/English/FAQ/NeckShoulder.html>).

To compensate on the bicycle for neck pain: raise the bars; change to a shallow drop; use a shorter stem and for some cases change to a frame with a shorter top tube.

Handlebars should be shoulder width apart (measured from Acromion to Acromion across the anterior chest) and comfortable. Handlebars that are too wide may cause excessive trapezius and rhomboid strain leading to muscle spasm and pain (Burke, 1994). While riding one must relax the upper body and not grip the handlebars tightly, rather try to change position on the bars often, as a rigid riding position transmits more shock directly to the neck and shoulders. Riding with unlocked elbows and changing hand position (i.e. from drops to brake hoods) can alter neck posture minimizing pain (Asplund, Webb and Barkdull, 2005).

Remember to take time to look around, thereby stretching the neck, and try shaking the hands (Brown, 2002). In addition, the amount of force the muscles need to exert in this region may be diminished by using a lightweight helmet, resulting in less muscular fatigue (Sheets and Hochschuler, 1990).

Periodic dynamic contractions of the lumbar musculature when riding should enhance blood flow to these areas, which may result in the removal of waste products and the possible reduction in pain, spasm and fatigue (Sheets and Hochschuler, 1990).

Off the bicycle, every cyclist must stretch the neck, shoulders, thoracic region and lumbar region to prevent stiffness. Neck pain is usually associated with upper and mid thoracic spine stiffness and dysfunction, where cervical and thoracic mobilization and manipulation can be helpful.

Nerve root irritation due to disc problems (narrowing or rupture) in the cervical region may manifest as pain down the arm to the hand (Brown, 2002). A better understanding of the pathologic mechanism of musculoskeletal overuse injuries, specifically in cyclists, is key in developing good preventive and treatment strategies for the neck injuries (Asplund, Webb and Barkdull, 2005).

### **Lower back pain.**

Unfortunately many activities involve sitting and leaning forward, including cycling. The Transversus Abdominus and Multifidus muscles weaken in these postures (Simons, Travell and Simons, 1999). Pelvic position also contributes to back pain, as a misaligned pelvis will cause strain to the back musculature.

Tight quadriceps femoris will tend to tilt the pelvis forward, while tight hamstrings predispose to backward pelvic tilt (Asplund, Webb and Barkdull, 2005).

Failure of the hamstring muscles to elongate normally increases the stress placed on the posterior elements of the lumbar spine, especially if the spine is in a forward flexed position, because the extensor muscles of the lower back are already elongated and cannot dissipate the applied stress (Schafer and Faye 1989).

On the bicycle, pushing large gears or extended hill climbing may fatigue the gluteus and the hamstrings, causing the pelvis to tilt backwards, aggravating the back musculature, causing pain (Asplund, Webb and Barkdull, 2005).

In low aerodynamic positions the quadratus lumborum muscle fatigues with an accompanying dull ache in the lower back. The remaining core muscles also become compromised and become less effective, which in turn causes the gluteus muscle to tire causing a drop in speed and power (Howard and Ferrel, 2002).

Combined with inadequate spinal movement, stiff spinal joints and the discs beginning to degenerate, the adult disc is for the most part avascular and hence relies on movement of the dynamic segment to enhance blood supply by diffusion across the endplate. If this movement is not present, the necessary nutrients can not enter the disc and the metabolic wastes can not leave, which in itself may cause pain (Sheets and Hochschuler, 1990).

The end result of dehydration of the disc is failure or collapse of the disc, which may protrude, rupture or irritate the sciatic nerve resulting in sciatica

(<http://www.bicyclefitting.com/English/FAQ/LowBack.html>). Segmental dysfunctions develop, often seen in the T12/ L1/L2 and the L5/S1 regions in cyclists (T=Thoracic, L=Lumbar AND S=Sacral)

(<http://www.bicyclefitting.com/English/FAQ/LowBack.html>).

To compensate on the bicycle, adjust the saddle to the correct height, with the nose of the saddle slightly down  $\pm 10^\circ$  from the horizontal and ensure correct reach and bar height. Once again check for leg length discrepancies and adjust to fit the longer leg. Stretch and change position on the bicycle frequently, using lower gears. One should also check the saddle for warping, as saddles can warp as a result of cycling (<http://www.bicyclefitting.com/English/FAQ/LowBack.html>)

Off the bicycle, according to Glisan and Hochschuler (1990), weakness of the anterior musculature may lead to excessive Lordosis of the lumbar spine, increasing the potential risk for spinal injuries. There is a need to activate, co-ordinate and strengthen the core stability muscles. Mellion (1994) has designed a good stabilization exercise program. Asplund, Webb and Barkdull (2005) concur and believe that the strength of the abdominal muscles is critical to maintaining stable pelvic positioning. Core muscle group strengthening and lower extremity stretching will help with proper pelvic positioning and lead to pedaling efficiency.

According to Brown (2002), physiotherapists, osteopaths, chiropractors and doctors trained in manipulative techniques, are able to provide the relevant treatments needed.

### **Sitting problems.**

The occurrence of saddle pain depends on the physical shape the cyclist is in, the use of appropriate clothing and the cyclist's saddle fit. Proper saddle width depends on the width of the pelvis, the distance between the Ischial tuberosities, and the position of the upper part of the body.

Women tend to have a wider pelvis than men, thus normally ride a wider saddle. In a straight up position a wider saddle will be more comfortable, whereas, if the upper body is bent a narrower saddle may feel more comfortable (<http://www.bicyclefitting.com/English/FAQ/Sitting.html>).

### **Leg length inequalities (LLI).**

LLIs are tolerated in normal day-to-day living but in cycling they can become more apparent because of the cyclists relatively fixed position on the bicycle and high repetitions per minute (Burke and Pruitt, 2003). The first indication of an LLI will be back pain, which is caused by a constant transverse tilt of the pelvis.

This pelvic tilt is the result of the unequal pedal stroke relative to the leg length, causing some degree of twist to the spine depending on the angle of the back relative to the pelvis. Often LLIs of a significant difference can precipitate in a Sacro-iliac lesion (Hyde and Triano, 1990).

Other complaints that may be a result of a LLI may be knee and hip complaints caused by the misalignment

([http://www.billbostoncycles.com/lower\\_limb\\_inequality.htm](http://www.billbostoncycles.com/lower_limb_inequality.htm)).

In this respect Burke and Pruitt (2003) believe that LLI must be determined to be functional (apparent shortening) or structural (true shortening).

Functional leg length differences are the result of compensation for a change that may have occurred because of positioning rather than structure. For example, a functional leg length discrepancy could occur because of unilateral foot pronation or spinal scoliosis. On the bike, foot mechanics can be corrected with orthotics and bicycle fit adjustments (Magee, 1997).

Structural leg length discrepancies, as the name suggests, are caused by an anatomic or structural change in the lower leg resulting from congenital maldevelopment (adolescent coxa vara, congenital hip dysplasia, bony abnormality) or trauma (fracture).

An anatomic short leg often affects the spine and pelvis, leading to lateral pelvic tilt and scoliosis (Magee, 1997). On the bike, structural LLI's can be treated with spacers, or saddle or foot position adjustments. The saddle height for cyclists with leg length discrepancies should always be adjusted to the long leg (Souza, 1996). Leg corrections are thus made on the shoe, the pedal of the short leg, or with the fore/aft positioning of the feet if the length discrepancy is in the femur. Tibial length discrepancies can be treated using spacers to equalize the lengths. These spacers can be between the shoe and the cleat, or within the shoe.

Corrections of length should slightly under-compensate for the total difference, as many cyclists correct with exaggerated plantar flexion or dorsiflexion of the ankle (Souza, 1996) (ankling-see figure 10 below). Differences of 4mm or less do not require correction unless the cyclist is symptomatic (Burke and Pruitt, 2003).



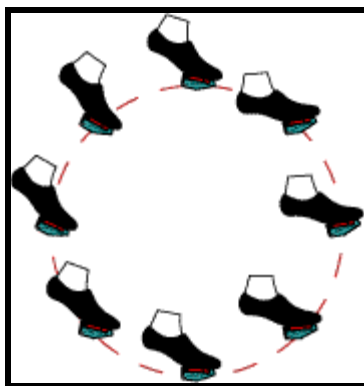

Figure 10: Diagram showing Ankling, Adapted from  
<http://bicycling.com/English/Theory/FootPosition.aspx>

## **Knee pain.**

### **Anterior knee pain.**

Patellar-tendinopathy is often very tender and well localized to the lower end of the patella, normally due to eccentric injury. The pain is felt with resisted knee extension at any point along the extensor mechanism, including the patella, patellar tendon, or its attachment into the tibial tuberosity (Souza, 1996).

Patello-femoral pain syndrome (P.F.P.S), is caused by maltracking of the patella in the femoral groove between the femoral condyles or patellar tendinopathy (Brown, 2002) or is due to irritation of surrounding structures, such as the retinaculum, fat pad, and ligaments, without damage to the hyaline cartilage of the patella (Souza, 1996). In advanced cases the damage results to the cartilaginous surface of the patella resulting in Chondromalacia patella (Souza, 1996).

In terms of cycling, causes of anterior knee pain include excessive forces pushing on the surface of the femur creating stress and shearing forces. This often results from a saddle that is too low, sudden increase in mileage, excessive hill climbing or pushing big gears. If the problem is only on the one side, then one needs to look for a leg length discrepancy (Brown, 2002).

On the bicycle, raise the saddle, spin more (85 revolutions /minute), avoid hills until the condition settles, avoid long cranks, use cleats with more float, check the cleat float, and use a wider bottom bracket (Brown, 2002). For leg length discrepancies always adjust to the longer leg and place a shim under the cleat of the shorter leg (Souza, 1996). If active foot pronation is present while pedaling, then one can use orthotics, specific for cycling shoes, to stabilize the foot. The use of cortisone should only be used as a one-off treatment and not on an on going basis (Brown, 2002).

Off the bike, Brown (2002), suggests one should avoid running, deep squats and weight training that put high load on the patella-femoral joint. Use weight bearing knee dips that are closed chain exercises, to improve strength and function of the stabilizing muscles. Souza (1996) recommends terminal knee extension exercises and Ilio-tibial band and Vastus lateralis stretching.

### **Posterior knee pain.**

The biceps tendon may be involved when the cyclist complains of posterolateral pain. Tenderness at the insertion into the fibular head or slightly proximal to the attachment is often found (Souza, 1996). Disorders in the lower back can also refer into this region and thus must be considered (Brown, 2002).

On the bicycle, one needs to check that the saddle is not too high (Souza, 1996), that one is not sitting too far back, dropping the heel during the pedal cycle or using too big a gear, having too much cleat float or muscle imbalance. Too much cleat float results in the hamstrings contracting to help stabilize the leg while pedaling. Muscle imbalance between the quadriceps and the hamstrings should be addressed.

In addition the cyclist should sit further forward, lower the saddle, avoid dropping the heel when pushing big gears, use hill work, limit cleat float to 5°, stretch the hamstrings and lower back musculature both on and off the bicycle, and check for leg length discrepancies (Brown, 2002).

A swelling in the posterior aspect of the knee could be a Baker's cyst, which can occur spontaneously, and may rupture giving rise to swelling in the calf muscle (Hope et al .1998).

In some cases an inflamed Patello-femoral joint will give rise to effusion on the knee. It is vitally important that any swelling not related to trauma on the knee should be assessed by a medical practitioner (Brown, 2002).

### **Medial Knee Pain.**

Medial knee pain is associated with Anserine tendonitis and / or bursitis often identified by insidious-onset pain over the medial proximal Tibial metaphysis approximately 2 to 4 cm below the joint line (Asplund and St. Pierre, 2004).

The anserine tendon attaches to the upper medial aspect of the tibia.

It is the junction of four muscles: the semitendinosus, semimembranosus, Gracilis and the Sartorius muscles (Reid, 1992). Direct trauma or repeated friction over the bursa can lead to inflammation. When the bursa is inflamed, contraction of the hamstring muscles, tibial rotation, and direct pressure over the pes anserine bursa usually produce pain. Medial joint line pain may also be an early sign of degenerative osteoarthritis in the knee (Brown, 2002).

On the bicycle, the cyclist's toes point too far outward or the knees are too far apart when cycling. Sometimes if the cleats have too much tension, exiting the clip-less pedals may cause stresses on the medial knee. Cyclists with turned-in tibia, foot pronation (flat –footed) and a Varus knee are pre-disposed to developing medial knee pain on that side. To compensate on the bicycle, limit the float to 5° degrees in the cleats, reduce the tension of the pedal release mechanism, reduce the bottom bracket axle width or use cranks with less off-set. Check the saddle position, reduce mileage and spin in a lower gear.

Sometimes a wedge is used between the cleat and the shoe, which causes the foot to tip outward if there is significant biomechanical misalignment. Running should be avoided (Brown, 2002).

### **Lateral knee pain.**

Ilio-tibial band syndrome (ITB syndrome) is usually characterized by the abrupt onset of a well-localized pain while pedaling. Ilio-tibial band syndrome is due to the irritation of the Ilio-tibial band from repetitive friction of the Ilio-tibial band over the lateral femoral condyle, which causes inflammation of the tendon and or bursa, or tight, thick, or widened ITB tendon (Souza, 1996). Contact of the Ilio-tibial band with the condyle is pronounced at about 30° of knee flexion and can be reproduced with orthopaedic tests such as Nobles compression test (Magee, 1997). Lateral knee pain is thought to be caused by too much pull on the outside of the knee possibly due to incorrectly adjusted cleats with the toe pointing in, using a narrow bottom bracket and low saddle, pushing big gears, excessive hill work, having a wide pelvis, bowlegs and tight gluteal muscles as well as trauma (Coppolillo, 2000).

On the bicycle, adjust the cleats to allow more toe out, change to float cleats limiting them to 5° float, increase the distance between the feet by using a wider bottom bracket, off set cranks or using a spacer between the cranks and pedal (Souza, 1996). It is also important to look for leg length discrepancies and remember to change the saddle height too.

One should reduce mileage, avoid hills, running, weight training and stretch the ilio-tibial band. In the early stages NSAIDS and cortisone can be used, and as a last resort only after a conservative approach should surgery be considered (Brown, 2002).

### **Foot and ankle.**

In cycling the feet are in a relatively fixed position, thus the cyclist has no choice but to adapt to the drive mechanism and risk possible injury if not adjusted correctly.

A shoe plate that is placed too far forward increases the instability of the foot, resulting in extra pressure on the Achilles tendon and the calf muscles.

This can also be a result of the saddle height being too low.

The cyclist compensates by pushing the heels downward in order to increase the distance between the saddle and the pedals.

(<http://bicycling.com/English/Theory/LongFoot.aspx>).

A burning sensation in the feet is often a result of the rigidity of the attachment between the foot and shoe and between the shoe and the pedal. The pressure under the foot is concentrated almost completely under the ball of the foot, while the attachment of the foot to the rigid sole is not always perfect. Often replacing the inner sole or the use of an orthopedic innersole solves the problem. Sometimes tingling and or numb toes can be as a result of an attachment of the foot to the shoe being too rigid. A cycling shoe only needs to provide stability to the heel, with a firm wedge under the arch of the foot in order to prevent excess pronation. The toes must have enough space to allow play and allow some movement

(<http://www.bicycling.com/English/FAQ/FootAnk.html>).

All the corrections above (on the bike) suggested for each condition are anecdotal and can currently only identify the problem through trial and error, thus further research is needed over a longer time period evaluating the long term effects of changes made to the set-ups on bicycles.

## 2.7 INJURY PREVENTION

Injury prevention can be viewed in three ways: preventing a problem from occurring at all (primary), preventing a problem from becoming a chronic condition once it has occurred (secondary), and preventing the problem from recurring once it has been resolved (tertiary). In this respect, the prevention of acute types of traumatic injuries could be limited by good cycle maintenance, bicycle-handling skills, helmet use, obeying the rules of racing and common sense.

Unfortunately, however, there is little research to help identify the measures that could best accomplish the prevention of these acute injuries, as well as the prevention of the chronic injuries that result (Brown, 2002).

In agreement with Brown (2002), Thompson and Rivara (2001), believe that prevention of cycling injuries should be divided into four aspects.

- Protective equipment:  
Protective equipment includes the use of helmets, gloves, glasses, padded shorts, shoes, bright and reflective clothing and lights.
- Mechanical problems:  
Mechanical problems can be minimized with the correct fit of the bicycle, regular safety checks, regular servicing, effective brakes and handlebar padding.
- Education:  
Education includes attending skills clinics, use of helmets, cyclists being trained to anticipate the errors of motorists, media and awareness campaigns for cyclists and motorists.
- Environmental conditions:  
Environmental conditions include: proper road design allowing area for cyclists, separate bicycle paths, maintenance of roads and cycle paths.

Rausch (2002) recommends cyclists should start and end rides with a stretching routine that includes back stretches, Achilles stretches and hamstring stretches.

Perkin (1998) in his research discussing the effect of stretching the hamstring muscles on low back pain, concluded that stretching not only increases the flexibility of the hamstrings, increases lumbar spine flexion range of motion, decreases the perception of pain and also decreases the disability associated with the pain. Therefore stretching should be done by all cyclists.

With the increased popularity of cycling as a sport amongst the younger generation it is imperative that further research in this field is completed. As Mellion (1991) believes, management of overuse injuries in cycling generally should involve identified mechanical adjustments to the bicycle as well as relevant medical management of the cyclist's complaints.

Thompson and Rivera (2001) also suggest that physicians treating patients with overuse injuries should consider medical factors, as well as adjusting various components of the bicycle. According to Pfeiffer and Kronisch (1995), this can be attained through future research, which incorporates epidemiological methods of data collection to determine the relationships between bicycle design, terrain and safety equipment. This view is supported by Brown (2002), who believes that there is a remarkable lack of data on the prevalence and incidence of acute and overuse injuries in cyclists.

Therefore from the above literature it can be seen that there is a need for information on acute and overuse injuries pertaining to cyclists in general (road cyclists and mountain bicyclists). This research aims to investigate the injury profile of South African cyclists and to establish an association between injuries and bicycle set-up in a South African context.

## **CHAPTER THREE: MATERIALS AND METHODS**

### **3.1 BACKGROUND OF THIS STUDY**

The Chiropractic Student's Sports Questionnaire (CSSQ) (Appendix E) was developed as a tool for data collection and recording of information outside the Durban Institute of Technology Clinical setting. The CSSQ has been used over a number of years at various sporting events and a large volume of data has been collected.

Dr.C.M Korporaal used the CSSQ for the basis of her hockey questionnaire, which was then modified to form the Cycling Questionnaire (Appendix G), which was piloted, in the form of a focus group.

The group consisted of eight participants.

- Two were representatives from local bicycle shops,
- A dietician/cyclist,
- A sixth year Chiropractic student/ex cyclist,
- An optometrist/cyclist
- A photographic developer/cyclist,
- The researcher, and
- A scribe (supervisor).

These participants were enlisted via word of mouth with ten respondents coming forward and expressing interest in the focus group. Through a process of self - selection the focus group at its outset had eight participants (two of the respondents were unable to attend the focus group).

Before commencing the focus group each participant was required to:

- Read an information letter (Appendix A),
- Sign a confidentiality statement (Appendix B)
- Sign an informed consent form (Appendix C) and
- Sign a Code of Conduct (Appendix D)



In the focus group each participant was given a copy of both the original treatment record questionnaire (Korporaal, 2002) and an adapted Cyclist's Questionnaire (for use in this study-Appendix G). Comment was requested on any ambiguity or on layout of the Cyclist's Questionnaire.

The questions were discussed in sequential order. If inconsistencies were found or changes proposed, a unanimous vote was required to institute change. At the end of the discussion chance was given for any comment on the questionnaire.

A video of the proceedings was made and is available as evidence of the individuals involved and the content of the discussion.

The reason why a focus group was chosen, is based on the fact that within a questionnaire one needs to address issues that surround validity, the components of which are: face validity, construct validity, content validity and criterion validity. The definitions of these concepts and how they are addressed in the cyclist's questionnaire follows (definitions taken from Bernard, 2000 unless otherwise stated).

1. Face validity, is the simplest type of validity, which is determined by agreement between researchers and those with a vested interest in the questionnaire (i.e. interpreted in this study as those participants of the focus group), that 'on the face of it' the tool seems valid, unambiguous and easily interpreted by a layperson.
2. An instrument has content validity when the content of the questionnaire is considered effective, and well rounded enough to be able to assess a particular concept. This was achieved by having persons from various backgrounds, yet involved in cycling attending the focus group, as these focus group participants are able to conceptualize the treatment record questionnaire (Korporaal, 2002) within the context of the cycling fraternity.

3. Construct validity, measured how accurately answers to questions in a scale reflected theoretical predictions of a particular construct. The focus group was utilized to ensure that the questionnaire was sound in establishing that which it was to be used for within the context of the research aims and objectives.
4. Criterion validity was measured when a particular tool produced similar results when compared with another tool already known to be trustworthy. This is also called concurrent validity by Mouton (1996). This type of validity was not to be addressed as part of this current research and has only been included for completeness in discussing validity.

### **3.2 THE FOCUS GROUP DISCUSSION / FORUM**

#### **THE ANALYSIS OF THE FOCUS GROUP DISCUSSIONS - THEMES**

##### **EXTRAPOLATED**

- Order of the Questionnaire
- Injury profile of South African cyclists vs. International cyclists.
- Treatment use: SOAPE notes
- Recommendations to cyclist were recorded on a SOAPE note, e.g change in setup, handlebar tape, adjustments, frame size, saddle height, etc.
- Follow up study: what cyclists were complaining of currently and in the past, but not following on due to budget and time constraints.
- Treatment: at clinic, measurements: at bike shops
- Past treatments: look at Soape notes used previously.

##### **Patient information.**

- Hours per week cycling
- Gender
- Height and weight comparisons
- Years experience
- Dominant hand

- Fitness
- Profession
- Cross training

### **Protective clothing.**

- Helmet
- Gloves
- Sunglasses
- Padded shorts

### **Patient care.**

- Acute vs. Chronic

### **Previous injury.**

- Fractures: specify

### **Patient assessment.**

- NRS pain scale
- Leg length
- Inseam measurement
- Torso measurement
- Moved leg length and torso measurement
- Shoulder measurement included

### **Location of injury related to cycling**

- Concussion
- Left vs. right thigh compartment

### **Mechanisms of injury**

- Posture on the bike when tired, does the cyclist change posture on the bike?  
Percentage time the cyclist stands on the hills, and spinning vs. pushing big gears.
- Injuries sustained: during training, competition, climbing, sprinting, racing

- Falls

### **Clinical presentation.**

- Fractures -specify

### **Bicycle information.**

- Brand name-not important, as different brands are made in the same factory.
- Pedal type and size
- Tyre size and pressure
- Fork material: aluminum, carbon fibre, chrome moly (racer)... mountain bike: shock travel

As a result of the focus group a questionnaire was formulated which included the above suggestions and is described as follows.

Divided into 4 sections:

- Pertains to patient information  
This will be completed by the patient / researcher.
- Pertains to the last condition which the patient had  
This will be completed by the patient / researcher.
- Pertains to the current condition that the patient has.  
The researcher will complete this.
- Pertains to the bicycle set-up parameters that are going to be assessed. This will be completed by the researcher. (See Appendix G- The Cyclist Questionnaire)

## **3.3 DATA COLLECTION**

### **3.3.1 PARTICIPANT RECRUITMENT**

Participants were recruited from the various cycling shops in and around Durban, fliers were put up at the Durban Institute of Technology, advertising was done at local cycle events, local cycling clubs, via e-mail to cycling shops and magazines like, Bicycling SA and Ride magazine (Appendix L).

### 3.3.2 STUDY PROTOCOL AND DESIGN

#### 3.3.2.1 ALLOCATION OF SUBJECTS

A non-probability purposive sampling technique was used to attract participants.

#### 3.3.2.2 SAMPLE SIZE

125 participants

#### 3.3.2.3 SAMPLE ALLOCATION

Stratification was utilized in order to compare between

- 1) Road bikes
- 2) Mountain bikes on-road

	Road bikes		Mountain bikes on-road		Total
Total	49 Male	25 Female	25 Males	26 Females	125

At the onset of this research the number of female and male road cyclists was equal but the number of females was later reduced, as there was little response to the adverts and it is believed that there are fewer female road cyclists.

When the sample size of 125 was reached there were 49 male road cyclists, 25 female road cyclists, and 25 male mountain bike cyclists on road and 26 female mountain bike cyclists on road.

### **3.3.2.4 CRITERIA FOR ACCEPTANCE OF COMPLETED QUESTIONNAIRES**

#### **3.3.2.4.1 Participant Inclusion criteria.**

1. Those wanting to participate in the questionnaire had to be 18 years and older (Perkin 1998)
2. The participant had to be a cyclist, cycling 60 kilometers a week. (Perkin 1998)

#### **3.3.2.4.2 Patient Exclusion criteria.**

1. Participants will be excluded if they are under the age of 18 years age as per the inclusion criteria.
2. Participants will be excluded if they have participated in the Face- validity testing of the questionnaire.
3. Cyclists who were not cycling 60 km/week were excluded.

#### **3.3.2.4.3 Inclusion of the questionnaire.**

Only completed questionnaires would be considered in the study where information provided will be considered accurate and truthful. In addition to the above the patient/cyclist would be asked to complete an informed consent form in order to be accepted into the study.

#### **3.3.2.4.4 Exclusion criteria of the questionnaire.**

Incomplete questionnaires and informed consent forms will be excluded from the study.

### **3.3.2.5.CONFIDENTIALITY CLAUSES**

#### **3.3.2.5.1 FOCUS GROUP CONFIDENTIALITY**

All data discussed or used within the focus group to arrive at a decision and or trends were kept confidential and a code of conduct was adhered to. The participants of the focus group were required to sign an informed consent form and received a letter of information. The focus group was at all times kept anonymous and transcripts, documents and tape recordings of the focus group proceedings were kept confidential and destroyed as appropriate (shredded or incinerated)

#### **3.3.2.5.2 PATIENT CONFIDENTIALITY, IN TERMS OF THE INFORMATION DATABASE**

A file number, so as to make the association of their patient details to their names inaccessible to the researcher once the data have been captured, replaces each participant's name

### **3.3.2.6 DETAILED DATA COLLECTION AND THE INTERPRETATION PROCEDURE**

#### **3.3.2.6.1 CLINICAL PROCEDURE:**

- Participants were recruited from the various cycling shops in Durban, fliers at the Durban Institute of Technology, advertising at local cycle events, local cycling clubs, via e-mail to cycling shops and magazines for example: GO-MULTI, Bicycling S.A. and Ride magazine (Appendix L).
- Telephonic interview: this excluded any subjects who did not fit the research criteria.
- Free Initial consultation
- Subjects were asked to read a Letter of Information (Appendix M) and complete an Informed Consent form (Appendix N) prior to completing a Cyclists' Questionnaire (Appendix G) a Case history (Appendix H), Physical (Appendix I), Regional (Appendix J) and S.O.A.P.E. note (Appendix K).

- Free consultation based on the diagnosis made in the free initial consultation.
- Subsequent consultations were on an outpatient basis and could be completed by any of the students, based on the patient's time and availability for treatment.

### **3.4 DATA ANALYSIS**

#### **3.4.1 INJURY PROFILES**

Questionnaire data and clinical examination of 125 cyclists were used to take a snapshot of the state of the cyclists at the time of the study to determine injury profiles of cyclists in South Africa. Profiles were set-up based on the following.

- 1) The number of cyclists in each group (i.e.: males on racers, females on racers, males on mountain bikes, and females on mountain bikes) with and without reported bicycling related injuries and with current clinical presentations.
- 2) The number of cyclists in each group with and without a bicycle related injury and clinical presentation of a specified anatomical location (e.g.: hand, neck, knee etc.).
- 3) Number of cyclists in each group with a bicycle related injury and clinical presentation of a specified nature (e.g.: sprain, contusion, etc.).

#### **3.4.2 INJURIES VERSUS CYCLIST AND BICYCLE**

To determine whether the different aspects of the cyclist (e.g., gender and cycling behaviour), bicycle type, bicycle dimensions, and bicycle set-up, as collected in the questionnaire, significantly affect the occurrence and likelihood of specific injuries, logistic regression analyses were performed.

Because of low sample size and few occurrences of many injury types and locations, reported injuries and clinical presentations were grouped into categories that could be properly analysed.



Reported injuries were grouped into four location categories

- Cyclist complaint\_1: head, neck, thoracic and ribs.
- Cyclist complaint\_2: shoulder, elbow, forearm, wrist, hand, thumb and fingers
- Cyclist complaint\_3: lower back, buttocks
- Cyclist complaint\_4: thigh, knee, shin, calf, ankle and foot.

Clinical presentations were grouped into 4 location categories

- Clinical Presentation\_1: head, neck, thoracic, Erector Spinea
- Clinical Presentation\_2: upper limb
- Clinical Presentation\_3: pelvis, lumbar, Erector Spinea, Quadratus Lumborum, Sacro-Iliac
- Clinical Presentation\_4: lower limb, rectus fem, iliopsoas and Gluteus Medius.

Only two types of clinical presentations (Myofascial and SI syndrome), had sufficient numbers of patients presenting to be analysed. All analyses were performed using SPSS 11.0. Statistical significance was set at  $p < 0.05$ .

## **CHAPTER FOUR- RESULTS**

### **4.1. INJURY PROFILES**

Injury profiles for each bicycle type and gender are summarized in Table 4.1. When anatomical locations were grouped for the analyses (to allow inclusion of the infrequently reported injuries), lower limb injuries were the most common (67%), followed by those of the upper limbs (59%), lower back/buttocks (56%), and head/neck/thoracic/ribs (48%). Males most commonly reported lower limb injuries (70%), with 66% reporting lower back and buttock problems, 57% having had upper limb injuries, and 51% reporting head/neck/thoracic/rib injuries. Both lower limb and upper limb complaints were reported in 63% of females, with 43% and 41% reporting injuries to the head/neck/thoracic/ribs and lower back/buttocks regions, respectively. In terms of clinical presentations, the injuries of the pelvis, lumbar, Erector Spinea, Quadratus Lumborum, Sacro-Iliac region were most common for all cyclists combined (27%), as well as for males (34%) and females (18%) separately. Lower limb conditions were next common for males (30%), while head/neck/thoracic problems were second most common for females (16%).

The most common specific anatomical sites for injuries reported by males and females combined were lower back (51%), knee (42%), neck (42%), hand (38%) and shoulder (24%) (Table 4.1). Looking at the genders separately, males most commonly reported injuries of the lower back (59%), knees (46%), hands (41%), and neck (39%), and females more frequently reported injuries relating to the neck (47%), lower back (39%), and knee (also 39%).

When road and mountain bikes are compared, lower limb complaints were the most common for road cyclists (74%) and head/neck/thoracic/rib complaints were the most frequent for cyclists on mountain bikes (61%), and pelvis/lumbar injuries were the most frequently assessed for both road (36%) and mountain (14%) bikes (Table 4.1).

In terms of specific anatomical locations, lower back (54%), neck (51%) and knee (46%) complaints were the most common for road bikes (Table 4.1). For mountain bikers riding on the road, lower back (47%), knee (39%), and hand (33%) complaints were the most common.

There were sufficient Myofascial and Sacro-Iliac joint syndrome presentations to allow for comparisons between genders and bike types. Both conditions were more frequently assessed for males (46% and 20%, respectively) than females (29% and 16%) and for road bikes (53% and 26%) than mountain bikes (20% and 8%) (Table 4.1).

## **4.2. CONDITIONS INCREASING ODDS OF INJURIES**

The cyclist and bicycle traits that significantly increased the odds of injuries occurring are presented in Table 4.1 (cyclist complaints; grouped anatomical locations and clinical presentations). Details of all cyclist and bicycle variables are summarized in Appendix O (Table 4.4 and 4.5)

### **Cycling complaints.**

The odds of having injuries related to the head/neck/thoracic/rib region (Cycling complaint\_1) were higher for road bikes than for mountain bikes (109% increase in odds, or approximately twice as likely) and for non-suspension versus suspension fork (126% increase) (Table 4.2). Odds increased by 0.2% for each 1kPa increase in tyre pressure and by 90% for each size too large the bike was for the cyclist (e.g., 90% increase if Large bike is ridden instead of Medium, and a 180% increase if X-Large is ridden instead of Medium).

Injuries to the lower back and buttocks (Cycling complaint\_3) were more likely for males (odds were 180% greater than those for females), for cyclists who also played soccer (odds increased 78% over those of non-players), and for cyclists who predominantly push big gears rather than spin lower gears at a higher cadence (133% increase in odds) (Table 4.2).

Additionally, odds increased by 0.7% for each additional km ridden per week, on average; 18% for each additional hour ridden per week, on average; and 130% for each 1 cm increment in leg length inequality.

Lower limb injuries were more probable for road bikes (130% increase in odds over mountain bikes), carbon fibre forks (65% increase in odds over other forks), and for platform pedals and platform pedals with cages (odds were 47% greater than those for non-platform pedals) (Table 4.2). Odds also increased 0.5% for each additional km ridden per week, on average; 17% for each additional hour ridden per week, on average; 0.1% for each 1kPa increase in tyre pressure; and 1.9% for each 1 degree reduction in stem angle.

### **Clinical Presentations.**

The odds of head/neck/thoracic region (Clinical Presentation\_1) injuries were greatest for cyclists who also played soccer (odds increased 69% over non-players), who used narrow back saddles (odds increased 68% over all other saddle types) and aluminium forks (76% increase in odds over other fork materials), and who rode with higher tire pressure (odds increased 0.2% for each 1-kPa increase).

Injuries involving the pelvis, lumbar, Erector, Quadratus Lumborum muscles, and Sacro-Iliac joints (Clinical Presentation\_3) had greater odds for males (138% increase in odds over females), swimmers (64% increase over non-swimmers), road bikes (218% increase over mountain bikes), non-aluminium forks (214% increase over aluminium forks), and cleats (261% over other types of pedals) (Table 4.3). Odds also increased 0.6% for each additional km ridden per week, on average; 2.3% for each 1-degree reduction in stem angle; and 7.8% for each 1 cm reduction in the difference between handlebar and shoulder width.

Injuries to the lower limb, Rectus Femoris, Iliopsoas, and Gluteus Medius muscles (Clinical Presentation\_4) had greater odds for males (166% greater than for females), road bikes (odds 268% greater than mountain bikes), forward seat position (odds 74% greater than central and back seat positions), and cleats (odds 230% greater than other types of pedals) (Table 4.3). Odds increased 4.5% for each 1-year increase in cyclist age; 0.2% for each 1-kPa increase in tire pressure; 3.1% per 1-degree reduction in stem angle; and 8.6% for each 1-cm reduction in (handlebar width – shoulder width).

The odds of myofascial injuries were greatest for road bikes (408% increase over mountain bikes), bent forward riding posture (77% increase over upright and backwards leaning postures), carbon fibre forks (67% greater than other fork materials), non-suspension forks (291% increase over suspension forks), and cleats (380% increase over other types of pedals) (Table 4.3). Odds increased 1% for each additional km ridden per week, on average; 28% for each additional hour ridden per week, on average; 0.3% for each 1kPa increase in tire pressure; 3.3% for each 1 degree reduction in stem angle; and 8.3% for each 1-cm reduction in (handlebar width – shoulder width).

The odds of Sacro-Iliac syndrome were greatest for road bikes (339% increase over mountain bikes), carbon fibre forks (69% increase over other fork materials), and platform pedals and platform pedals with cages (odds were 83% greater than those for non-platform pedals). Odds increased 0.7% for each additional km ridden per week, on average; 17.5% for each additional hour ridden per week, on average; and 2.8% for each 1 degree reduction in stem angle; and 8.1% for each 1-cm reduction in (handlebar width – shoulder width).

**Table 4.1:** Injury profile by gender and bicycle type. Data presented as number of patients with and without injuries in each category and group.

Injury <sup>1</sup>		Total	Male <sup>2</sup>		Female <sup>2</sup>	
			Road	Mountain	Road	Mountain
Specific complaints <sup>3</sup>						
Neck	yes	53	25	4	13	11
	no	72	24	21	12	15
Shoulder	yes	30	9	6	7	8
	no	95	40	19	18	18
Hand	yes	47	23	7	7	10
	no	78	26	18	18	16
Thoracic	yes	12	3	2	4	3
	no	113	46	23	21	23
Lower back	yes	64	29	15	11	9
	no	61	20	10	14	17
Thigh	yes	26	16	4	1	5
	no	100	33	21	24	21
Knee	yes	53	22	11	11	9
	no	72	27	14	14	17
Foot	yes	25	8	2	9	6
	no	100	41	23	16	20
Complaint_1	yes	60	19	19	10	12
	no	65	30	6	15	14
Complaint_2	yes	74	32	10	14	18
	no	51	17	15	11	8

Complaint_3	yes	70	32	17	11	10
	no	55	17	8	14	16
Complaint_4	yes	84	37	15	18	14
	no	41	12	10	7	12
Clinical Presentation_1	yes	25	15	2	4	4
	no	100	34	23	21	22
Clinical Presentation_2	yes	5	4	0	0	1
	no	120	45	25	25	25
Clinical Presentation_3	yes	34	21	4	6	3
	no	91	28	21	19	23
Clinical Presentation_4	yes	29	18	4	5	2
	no	96	31	21	20	24
Clinical Presentation_Myofascial	yes	49	29	5	10	5
	no	76	20	20	15	21
Clinical Presentation_SI Syndrome	yes	23	13	2	6	2
	no	102	36	23	19	24

---

1 Cyclist complaint: 1=head, neck, thoracic, ribs; 2= shoulder, elbow, forearm, wrist, hand, thumb, fingers; 3= lower back, buttocks; 4= thigh, knee, shin, calf, ankle, foot. Clinical Presentation: 1: head, neck, thoracic, Erector Spinea; 2: upper limb; 3: pelvis, lumbar, Erector Spinea, Quadratus Lumborum, Sacro-Iliac; 4: lower limb, rectus fem, iliopsoas, and gluteus medius.

2 Sample sizes: male/road = 49; male/mountain = 25; female/road = 25; female/mountain = 26

3 Only locations reported for >10 subjects are included

**Table 4.2:** Significant relationships observed in logistic regression analyses comparing the odds of patients with complaints vs. those without complaints (1: head, neck, thoracic, ribs; 2: shoulder, elbow, forearm, wrist, hand, thumb, finger; 3: lower back, buttocks; 4: thigh, knee, shin, calf, ankle, foot). In all cases, n = 125 cyclists.

Explanatory variable	P	r <sup>2</sup>	Group with highest odds	Change in odds (%)
<b>Cyclist complaint_1</b>				
Tire pressure (kPa)	0.005	0.087	high pressure	0.2
Fork material (suspension vs. others)	0.042	0.045	non-suspension	126.4
Size difference	0.005	0.092	bike too big	89.7
Bike type	0.045	0.043	road	108.9
<b>Cyclist complaint_2</b>				
Nothing significant				
<b>Cyclist complaint_3</b>				
Gender	0.006	0.08	male	180
km per week	0.003	0.104	higher mileage	0.7
hr per week	0.014	0.072	higher time	18
Soccer	0.004	0.101	players	78.2
Leg length inequality (actual; cm)	0.01	0.077	bigger difference	129.9
Push big gears vs. spin	0.022	0.056	big gears	133.3



---

 Cyclist complaint\_4

km per week	0.04	0.052	higher mileage	0.5
hr per week	0.029	0.06	higher time	17.2
Bike type	0.032	0.051	road	130
Tire pressure (kPa)	0.043	0.046	higher pressure	0.1
Stem angle (°)	0.033	0.051	lower angle	1.9
Fork material (Carbon fibre vs. others)	0.027	0.06	carbonfibre	64.8
Pedal type (platforms/cages vs. others)	0.002	0.101	platforms/cages	46.5

---

**Table 4.3:** Significant relationships observed in logistic regression analyses comparing the odds of patients with Clinical presentations vs. those without Clinical Presentations: 1: head, neck, thoracic, Erector Spinea; 2: upper limb; 3: pelvis, lumbar, Erector Spinea, Quadratus Lumborum, Sacro-Iliac; 4: lower limb, Rectus Femoris, Iliopsoas, and Gluteus Medius. (Myofascial and SI Syndrome on their own). In all cases, n = 125 cyclists.

Explanatory variable	P	r <sup>2</sup>	Group with highest odds	Change in odds (%)
Clinical Presentation_1				
Soccer	0.015	0.07	players	69.3
Tire pressure (kPa)	0.044	0.054	higher pressure	0.2
Saddle type (narrow back vs. others)	0.014	0.079	narrow back	68.4
Fork material (Aluminium vs. others)	0.003	0.109	aluminium	75.5
Clinical Presentation_2				
Nothing Significant				
Clinical Presentation_3				
Gender	0.05	0.047	male	138.1
km per week	0.014	0.071	higher mileage	0.6
Swim	0.017	0.069	swimmer	64.3
Bike type	0.011	0.081	road bike	217.8
Stem angle (°)	0.027	0.061	lower angle	2.3

---

Handlebar width - shoulder width (cm)	0.004	0.107	smaller difference	7.8
Fork material (aluminium vs. others)	0.031	0.062	non-aluminium	214.3
Pedal type (cleats vs. others)	0.014	0.103	cleats	260.7
Clinical Presentation_4				
Gender	0.042	0.054	male	165.7
Age (yr)	0.024	0.062	older	4.5
Bike Type	0.009	0.09	road	267.7
Seat position (forward vs. others)	0.005	0.09	forward	74.4
Tire pressure (kPa)	0.049	0.049	higher pressure	0.2
Stem angle (°)	0.01	0.091	lower angle	3.1
Handle bar width - shoulder width	0.004	0.116	smaller difference	8.6
Pedal type (cleats vs. others)	0.032	0.074	cleats	230
Clinical Presentation_Myofascial				
km per week	0.000	0.191	high mileage	1
hr per week	0.000	0.151	high time	27.9
Bike Type	0.000	0.17	road	408.2
Tire pressure (kPa)	0.000	0.142	high pressure	0.3

---

---

Stem angle (°)	0.001	0.128	low angle	3.3
Handle bar width - shoulder width (cm)	0.001	0.141	Smaller difference	8.3
Posture (bent forward vs. others)	0.006	0.096	bent forward	76.8
Fork material (Carbon fibre vs. others)	0.005	0.083	Carbon fibre	67.3
Fork material (suspension vs. others)	0.004	0.101	non-suspension	291.3
Pedal type (cleats vs. others)	0.001	0.139	cleats	380
Clinical Presentation_SI Syndrome				
km per week	0.004	0.11	high mileage	0.7
hr per week	0.022	0.069	high time	17.5
Bike type	0.011	0.099	road	339.1
Stem angle (°)	0.029	0.07	low angle	2.8
Handle bar width - shoulder width (cm)	0.013	0.095	Smaller difference	8.1
Fork material (Carbon fibre vs. others)	0.015	0.075	carbonfibre	68.6
Pedal type (platform/cage vs. others)	0.023	0.095	platform/cage	82.5

---

## **CHAPTER FIVE: DISCUSSION AND CONCLUSION**

In comparison to other cyclist profiles, the South African profile is most consistent with that of Wilber et al. (1995). Their study of cyclists in the U.S.A found that the most common anatomical sites for overuse injuries reported by male and female cyclists combined were neck (48,8%), followed by knees (41,7%), groin / buttock (36,1%), hands (31,1%) and back (30,3%). Of 125 South African cyclists examined in the current study, 42.4% reported neck injuries and knee problems respectively, 37.6% reported hand injuries, and 51.2% complained of lower back pain. Looking at genders separately, Wilber et al. (1995) found 44.2 % of male and 54.9% of female recreational cyclists presenting for medical treatment of neck pain, while approximately 30% of both males and females presented with back pain. Out of 74 male and 51 female South African cyclists, 39% and 47% reported neck injuries respectively, and 59% and 39% had lower back pain. Other studies in the Netherlands and U.S.A. have found from 18% (Stevens 1998, as cited in <http://bicyclefitting.com/English/Theory/FAQ>) to 60-70% of cyclists with knee complaints (Holmes et al. 1994) and as high as 65% of cyclists with lower back injuries (Stevens 1998, as cited in <http://bicyclefitting.com/English/Theory/FAQ>).

Previous injury profiles have looked at either road cyclists (Holmes et al. 1994, Wilber 1995, Stevens 1998) or off-road mountain bikers (Kronisch and Rubin 1994). The profile of on-road mountain bikers arising from this South African study is the first to our knowledge. From the 51 on-road mountain bikers in this study, lower back complaints were the most common (47%), followed by knee (39%), hand (33%), and neck (29%) injuries. Kronisch and Rubin (1994) found 37% of off-road mountain bikers complaining of lower back pain, 30% with knee problems, and 19% with hand complaints, indicating that off- and on-road mountain bikers might have substantially different injury profiles. It appears that injuries associated with the use of mountain bikes on road are a mixture of road and mountain bike profiles, with the incidence of lower back pain and neck pain increasing from mountain bike usage off-road to usage on road, the worst seen in road bike usage.

A possible explanation is that mountain bike cyclists off- road are constantly changing seat and standing positions, allowing the lower back muscles to relax and allowing better blood flow to the structures in the lower back.

In this study, the cyclists riding road racers were more prone to various injuries than were the mountain bikers. The odds of a cyclist reporting injuries to the head, neck, thoracic, rib region and, the thigh, knee, shin, calf, ankle, foot, being assessed with myofascial injuries and Sacro-iliac joint syndrome were 109%, 130%, 408%, and 339% greater for riders of road racers, respectively. This could be due to road racers being characterized by the combination of increased flexion of the lumbar spine while riding, higher tyre pressures, higher average mileage per week (km/wk) and more time spent on the bike (hrs/week). The reported injuries to the neck and thoracic region may be caused by extra tension developing in the muscles of the shoulder, neck and upper spine resulting from keeping the neck in a hyper-extended position (Simons, Travell and Simons, 1999) for prolonged periods. Prolonged hyperextension of the neck and associated muscle strain may lead to trigger points in the muscles of the neck and upper back (Asplund *et al.* 2005). The jarring and vibration can aggravate this problem (Simons, Travell and Simons 1999) especially when riding with high tyre pressure.

Other factors significantly related to increased odds of injury were tyre pressure, average mileage and hours ridden per week, and stem angle. The higher the tyre pressure, the harsher the ride, transferring more of the vibrations and jarring from the road through the wheels and the frame and into the cyclist, which may contribute to the development of myofascial problems. Higher riding mileage and more time spent on the bike increase the possibilities for overuse injuries (e.g., myofascial injuries and Sacro-iliac syndrome). With the repetitive action involved in the cycling movement, a slight biomechanical flaw through one revolution is insignificant, but when multiplied by 5000 revolutions per hour the smallest point of weakness or misalignment may lead to dysfunction, pain and impaired performance (Holmes *et al.* 1994).

A lower stem angle effectively lowers the cyclist, creating a larger curve in the lumbar region and putting more weight onto the handlebars, thus potentially contributing to lumbar injuries.

An unexpected result from this study is the negative relationship between the difference between handle bar width and shoulder width, and the increased odds of injuries to the pelvis, lumbar, Erector Spinea, Quadratus Lumborum, Sacro-Iliac region, lower limb, Rectus Femoris, Iliopsoas, Gluteus medius region, and Myofascial and Sacro-Iliac joint conditions. Past research proposed that most cyclists select a handlebar that is the width of their shoulders, measured as the distance between the shoulders, or from the other Acromion (point of the shoulder) across the chest to the Acromion (between the shoulder joints) (<http://www.coloradocyclist.com/bicyclefit/>). In this study, the closer the handle bar width was to a cyclist's shoulder width, the higher were the odds of having an injury. One explanation for this could be that when the handlebars are similar in width to the cyclist's shoulder width the cyclist may have a greater tendency to ride with locked elbows, thus transferring the vibration effects up into the cyclist. Narrower bars have also been blamed for causing nervous steering (<http://bicyclefitting.com/English/Theory/Comfort.aspx>), which could be combined with cyclists holding onto the handlebars a little tighter, which could then be contributing to Myofascial problems.

Other factors related to the odds of cyclists experiencing injuries are gender, fork material and type and pedal type. Males were more likely to report lower back/buttocks injuries than females and also more likely to be assessed with injuries to the pelvis, lumbar, Erector Spinea, Quadratus Lumborum, Sacro-Iliac region and the lower limb, Rectus Femoris, Iliopsoas, and Gluteus Medius region. This could be a result of males generally being less flexible than females. In terms of fork material, researchers in the past (Armstrong and Carmichael, 2003) have found that aluminium absorbs less shock than carbon fibre; thus cyclists riding aluminium forks should have a higher likelihood of Myofascial injuries than those riding carbon fibre.

Similarly, riders with suspension forks will experience less vibration and jarring, and, therefore, a reduced likelihood of Myofascial and other vibration-related injuries.

Cyclists wearing cleats had increased odds of injuries associated with the pelvis, lumbar, Erector Spinea, Quadratus Lumborum, and Sacro-Iliac region, the lower limb, Rectus Femoris, Iliopsoas, and Gluteus Medius region, and increased odds of myofascial injuries versus those using SPDs and platform pedals. This could indicate that cleat technology is not ergonomically sound and/or that many cyclists using cleats were doing so incorrectly. During the assessment, many cyclists' cleats had insufficient lubrication on the springs within the cleat release mechanism and/or excessive tension, thus causing the cyclists to use a considerable amount of force to exit the cleat, potentially increasing the risk of injury.

Discrepancies between “optimal” bicycle size based on rider size (Table 2.1 Road bicycle sizing Adapted from <http://www.giantbicycles.com/us/050.000.000/050.600.100.aspx>), versus actual bike size rarely increased the odds of injuries. However, the bigger the bike the more stretched out the cyclist will be, putting strain on the back and more weight on the hands (Burke and Pruitt, 2003). The smaller the bike the more cramped the cyclist becomes, resulting in poor handling and breathing problems (Burke and Pruitt, 2003). The apparent lack or rarity of effect of bike size and several other variables in this study could be due to the small sample size of cyclists (N = 125, with much smaller numbers for each injury/variable combination) assessed for the study. This small sample size both reduced the probability of finding significant relationships between injuries and variables (even if they do actually exist) and increased the probability of getting spurious significant relationships, which may, in fact, not actually exist. Therefore, variables that were infrequently or never found to be significantly related to injuries cannot be discussed with confidence. This should be taken into consideration when examining and/or applying the results of this study.



There were discrepancies between injuries reported by the cyclists and injuries assessed in clinical examinations, as well as discrepancies between analyses performed on these two classes of injuries.

The complaints reported by the cyclists represent what stood out for the cyclists in terms of past injuries attributed to cycling (subjective), while the assessed clinical injuries represented cyclist condition at the time of the study (objective). Therefore, factors that increased odds of reported injuries (complaints) may be more relevant to cycling-associated profiles than those found to be related to clinical presentations. Future research on this topic should include assessments done before and after cycling events, and before, during, and after intensive training seasons. Without follow-up or repeated assessments, it is not possible to ascertain, with confidence, which assessed injuries are in fact, related to cycling.

In conclusion, the results obtained in this study show the snapshot of injury profiles of South African cyclists on road bikes and those using mountain bikes on road, taking into account the influence of both the bicycle and the cyclist traits. When road and mountain bikes were compared, lower limb complaints were the most common for road cyclists and head/neck/thoracic/rib complaints were the most frequent for cyclists on mountain bikes, and pelvis/lumbar injuries were the most frequently assessed for both road and mountain bikes (Table 4.1). In terms of specific anatomical locations, lower back, neck and knee complaints were the most common for road bikes (Table 4.1). For mountain bikers riding on the road, lower back, knee, and hand complaints were the most common. There were sufficient Myofascial and Sacro-Iliac joint syndrome presentations to allow for comparisons between genders and bike types. Both conditions were more frequently assessed for males than for females and for road bikes versus mountain bikes (Table 4.1).

The most common variables in the logistic regression when looking at the association between injuries and bicycle characteristics in a South African context, were bike type, road bike, higher tyre pressures, higher average mileage per week (km/wk), lower stem angle and more time on the bike (hrs/week).

This study is to my knowledge the first looking at mountain bike use on road, and therefore serves as a forerunner to more research.

## **CHAPTER SIX: RECOMMENDATIONS AND FUTURE RESEARCH**

This study which consisted of 125 cyclists, set out to obtain a snapshot of the various cycling profiles of the male and female cyclists riding road bikes and those riding mountain bikes on road.

The study assumed that the data gleaned from the questionnaires were correct and all cyclists were honest. Some of the information relied on the recall of the cyclists, a subjective process, therefore the possible omissions of some of the information may have skewed the results due to inaccurate recall (e.g: past sporting history injuries and injuries while cycling). Therefore it is suggested that a prospective study be undertaken in this regard before the snapshot is completed.

The time period of the study needed to be shorter as the response waxed and waned. It was noticed that some individuals had more injuries during a specific part of the cycling season (e.g. during the Argus cycling tour). Many cyclists had the Argus cycling race as their goal for the year then did not race competitively again, although were still riding more than 60 km per week, they were included in the study. Questions on the questionnaire relative to cycling load and preparation for or participation in events should be noted.

Future research in this field should include a larger study based exclusively on the use of mountain bike use on the road. As the sample size in this study was small, some of the variables may have been more significant with a larger sample. Another study in the future would be to look at the change in set up over a period of time. The researcher could assess the cyclist's set up, make changes where deemed necessary, re-assess after a preset time period, and then see if the changes made to the set-up of the bike influenced the clinical presentations.

Cycling is viewed as an apparently non-weight bearing activity and in the past it was recommended that cyclists needed to cross train in order to prevent loss of bone mass.

It is believed that the forces produced by a cyclist either pushing big gears or those riding hilly terrain may promote a higher bone density than in those cyclists who spin.

From a Chiropractic point of view, more studies are needed to see how Chiropractic may reduce acute conditions while shortening recovery time, which could take place in events like the Cape Epic, where the cyclists race over many stages. Integration of knowledge of bike fit and Chiropractic management and treatment of the chronic over-use injuries encountered in cycling would benefit the cyclists and the acceptance of Chiropractic as effective condition management.

In addition to the above, more research is needed with respect to looking at the effect of cycling position and change in bike type on herniated discs, e.g. position of flexion as in racers, is contraindicated, whereas the upright position on a hard-tail or dual suspension mountain bike may be beneficial.

In conclusion, more research is needed to demonstrate the inter-relationship between epidemiological information of the cyclist, faulty biomechanics, micro trauma and pre-existing disease on the incidence and prevalence of acute and overuse injuries in cyclists.

## **REFERENCES**

- Armstrong and Carmichael, C. 2003. *The Lance Armstrong Performance Program*. UK: Rodale Ltd. pp 10-11. ISBN 1-4050-2102-0.
- Asplund, C., Webb, C., and Barkdull, T. 2005. *Cycling News-Neck and Back Pain in Bicycling* [online]. Available from: <http://www.Roadcycling.com> [Accessed 23/08/05].
- Asplund, C. and St Pierre.2004. Knee Pain and Bicycling. *The Physician and Sports medicine*. 32(4) [online]. Available from: [www.physsportsmed.com/issues/2004/0404/asplund.htm](http://www.physsportsmed.com/issues/2004/0404/asplund.htm) [Accessed 8/01/05].
- Bergman, T.F., Peterson, D.H. and Lawrence, D.1993. *Chiropractic Technique*. U.S.A.: Churchill Livingstone Inc. pp 43-44 and p133. ISBN 0-443-08752-0.
- Bernard, H. R. 2000. *Social Research Methods: Qualitative and Quantitative Approaches*. California: Sage Publications Inc. pp 51, 210, 207. ISBN 0 7619 1403 X.
- Brown, G. 2002. *High-performance Cycling*, Editor Jeukendrup, A.E. Champaign, IL: Human Kinetics Publishers. pp 227-229. ISBN 0-7360-4021-8.
- Brown, S. 2005. *Revisionist Theory of Bicycle Sizing* [online]. Available from: <http://www.sheldonbrown.com/frame-sizing.html> [Accessed 02/03/05].
- Burke, E.R. 1994. Proper fit of the bicycle. *Clinical Sports Medicine*. 13 (1): 1-14.
- Burke, E.R. and Newson, M.M. 1988. *Medical and Scientific Aspects of Cycling*. Champaign, Illinois: Human kinetics Books. p 6. ISBN 0-87322-126-5.
- Burke E.R. and Pruitt A.L. 2003. *High-tech cycling*, 2<sup>nd</sup> edition, Champaign, Illinois: Human Kinetics Books. ISBN:0-7360-4507-4.
- Coppolillo, R. 2000. *Pruitt Fit* [online]. Available from: bike.com – feature article [Accessed 09/09/02].
- Dorland's Pocket Medical Dictionary*, 25<sup>th</sup> ed. W.B.Saunders Company (1995:200).
- Firth, M. 2005. *Cycling performance tips* [online]. Available from: <http://www.cptips.com/bkefit.html> [Accessed 02/03/2005].
- Gilbert, K. and McCarthy, M. 1994. Deaths of cyclists in London: the hazards of motor traffic. *BMJ*; 308: 1534-1537 [online]. Available from: <http://bmj.bmjournals.com/cgi/content/full/321/7276/1582#SEC6> [Accessed 22/08/05].
- Glisan, B. and Hochschuler, S. H. 1990. *The Spine in Sport*. Philadelphia: Hanley & Belfus. p37. ISBN1-56053-005-7.

Harris, A. 2003. *Bike Fit and Set-Up* [online]. Available from: <http://www.sbraweb.org/setup.html> [Accessed 02/03/2005].

Holmes, J.C., Pruitt, A.L. and Whalen N.J. 1994. Lower extremity overuse in bicycling. *Clinics in Sports Medicine*, 13(1): 187-205. ISSN: 02785919.

Hope, R.A., Longmore, J.M., McManus, S.K. and Wood-Allum, C.A. 1998. *Oxford Handbook of Clinical Medicine* 4<sup>th</sup> ed. UK: Oxford University Press, p 694. ISBN: 0 19 262 783X.

Howard, J. and Ferrel, E. 2002. *Training for Cycling: Flexibility First* [online]. Available from: <http://www.johnhowardschool.com> [Accessed 9/19/02].

<http://bicyclefitting.com/English?Theory/Crank.aspx> [Accessed 17/08/2003].

<http://bicyclefitting.com/English/Theory/Comfort.aspx> [Accessed 17/08/2003].

<http://bicyclefitting.com/English/Theory/FAQ> [Accessed 17/08/2003].

<http://bicyclefitting.com/English/Theory/FootPosition.aspx> [Accessed 17/08/2003].

<http://www.bicyclefitting.com/English/FAQ/HandWrist.html> [Accessed 17/08/2003].

<http://bicyclefitting.com/English/Theory/LongFoot.aspx> [Accessed 17/08/2003].

<http://www.bicyclefitting.com/English/FAQ/NeckShoulder.html> [Accessed 17/08/2003].

<http://www.bicyclefitting.com/English/FAQ/Sitting.html> [Accessed 17/08/2003].

<http://dictionary.reference.com/search?q=derailleur> [Accessed 19/09/2005].

<http://dictionary.reference.com/search?q=ischial%20tuberosity> [Accessed 19/09/2005].

<http://www.giantbicycles.com/us/050.000.000/050.600.100.aspx> [Accessed 02/03/2005].

Hyde, T.E. and Triano J. J.1990. *The Spine in Sport*. Philadelphia: Hanley & Belfus. p246. ISBN1-56053-005-7.

Khan, K.M., Cook, J.L., Taunton, J.E. 2000. Overuse tendinosis, not tendonitis. *Phys Sports Med*. 28(5): 31-46.

Korporaal, C.M. 2002. *A retrospective epidemiological investigation of the Chiropractic Students' Sports Questionnaire, with reference to field hockey: a methodological perspective*. (Unpublished Dissertation) Technikon Natal.

- Kronisch, R.L. 1998. Mountain Biking Injuries: Fitting Treatment to the Causes. *The Physician and Sportsmedicine* 26(3). Available from: <http://www.physsportsmed.com/issues/1998/03mar/kronisch.htm> [Accessed 08/01/05].
- Kronisch R.L., Pfeiffer R.P., Chow T.K. and Hummel C.B. 2002. Gender differences in mountain bike racing injuries. *Clin J Sports Med* 12(3): 158-64. Available from: <http://www.ncbi.nlm.gov.fcgi> [Accessed 12/08/2002].
- Kronisch, R.L. and Rubin, A.L. 1994. Traumatic injuries in off-road cycling. *Clin J Sports Med* (4): 240-44.
- Lemond, G. and Gordis, K. 1987. *Greg LeMond's Complete Book of Bicycling*. New York City: Pedigree Books, pp 118-145.
- Magee, D.I. 1997. *Orthopedic Physical Assessment*. 3<sup>rd</sup> Edition, U.S.A.: W.B.Saunders Company.
- Mellion, M.B. 1991. Common cycling injuries. Management and Prevention. *Sports Med*, 11(1): 52-70. ISSN: 01121642.
- Moore, K.L. 1992. *Clinically Orientated Anatomy*, 3<sup>rd</sup> Edition. Baltimore, U.S.A.: Williams and Wilkins. p327.
- Mouton, J. 1996. *Understanding social research*. Pretoria: J.L. van Schaik Publishers. p62, p127, p129 and p141. ISBN 0 627 02163 8.
- Perkin, J.C. 1998. *The effect of stretching the hamstring muscles on low back pain in cyclists*. p34 (Unpublished dissertation) Technikon Natal.
- Pfeiffer, R.P. and Kronisch, R.L. 1995. Off road cycling Injuries. *Sports Med* 19(5): 311-25 [online]. Available from: <http://www.ncbi.nlm.gov.fcgi> [Accessed 09/2002].
- Pruitt, A.L. 2002. *Purchasing a bicycle* [online]. Available from: <http://www.bike.com> [Accessed 19/08/2002].
- Rausch, R. 2002. *Prevent Common Cycling Injuries* [online]. Available from: <http://www.swpt.com/> [Accessed 19/08/2002].
- Rehak, D.C. 2005. Overcoming overuse injuries- Cyclist's Hands. *Hughston Sports Medicine Foundation* [online]. Available from: [http://www.hughston.com/hha/a\\_15\\_3\\_2.htm](http://www.hughston.com/hha/a_15_3_2.htm) [Accessed on 22/08/05].
- Reid, D.C. 1992. *Sports Injury Assessment and Rehabilitation*. U.S.A.: Churchill Livingstone Inc. p554. ISBN 0-443-08662-1.
- Sacks, J.J., Kreshnow, M., Houston, B. and Russel, J. 1996. Bicycle helmet use among American children. *Injury Prevention* 2:258-262.

Schafer, R.C. and Faye L.J. 1989. *Motion palpation and Chiropractic Technique 1<sup>ST</sup> edition*. The Motion Palpation Institute. C.A.: Huntington Beach. p257. ISBN 0924889-00-4.

Sheets, C.G. and Hochschuler, S.H. 1990. *The Spine in Sport*. Philadelphia: Hanley & Belfus. p128. ISBN1-56053-005-7.

Sherry, E. and Wilson, S.F. 1998. *Oxford Handbook of Sports Medicine*. Oxford: Oxford University Press. p22 and p44.

Siegel, A.J. and Dawson, D.M. 2002. *Merriam-Webster Medical Dictionary* [online]. Available from: <http://www.dictionary.com/profile> [Accessed 29/08/2004].

Simmons, D.G., Travell, J.G., and Simmons, L.S. 1999. *Myofascial Pain and Dysfunction, The Trigger point Manual, 2<sup>nd</sup> Edition*. U.S.A.: Williams and Wilkins.

Souza, T. 1996. The Bicyclist, Part 2, *Dynamic Chiropractic* 14(25) [online]. Available from: <http://www.Chiroweb.com> [Accessed 9/06/05].

Stevens, A. 1998, as cited in <http://bicyclefitting.com/English/Theory/FAQ> [Accessed 19/08/2003].

Thompson, M.J., and Rivara, F.P. 2001. Bicycle related Injuries. *American Family Physician* (5).

US Department of Transportation: Bureau of Transportation Statistics: Bicycle use among adult US residents. *Omni Stats* 2002; 2(6): 1-3.

Wilber, C.A., Holland, G.J., Madison, R.E. and Loy, S.F. 1995. Epidemiological analyses of overuse injuries among recreational Cyclists. *Int J Sports Med.* 3(16): 201-6. ISSN: 01724622.

[www.bicyclingsource.com/bike-fitting](http://www.bicyclingsource.com/bike-fitting)) [Accessed: 19/09/02].

[www.billbostoncycles.com/lower\\_limb\\_inequality.htm](http://www.billbostoncycles.com/lower_limb_inequality.htm) [Accessed 02/ 03/05].

[www.billbostoncycles.com/top\\_tube\\_length.htm](http://www.billbostoncycles.com/top_tube_length.htm) [Accessed 02/ 03/05].

[www.birkenstock.com/health\\_wellness/sports/biking](http://www.birkenstock.com/health_wellness/sports/biking) [Accessed 22/08/2005]

[www.coloradocyclist.com/bicyclefit/](http://www.coloradocyclist.com/bicyclefit/) [Accessed 14/01/2005].

[www.coloradocyclist.com/bikefit/](http://www.coloradocyclist.com/bikefit/) How to fit Your Custom Bicycle [Accessed 14/04/05].

[www.giant-bicycles.com/us/050.000.000/050.600.100.aspx](http://www.giant-bicycles.com/us/050.000.000/050.600.100.aspx) [Accessed: 02/03/2005].

[www.wrongdiagnosis.com/lists/personal\\_injury.htm](http://www.wrongdiagnosis.com/lists/personal_injury.htm) [Accessed: 22/08/2005]



## **APPENDICES**

### **APPENDIX A: LETTER OF INFORMATION – FOCUS GROUP**

Dear Participant,

I would like to welcome you into the focus group of my study, the title of my research project is:

**An Investigation to establish an injury profile in South African cyclists and it's association to bicycle set-up.**

The purpose of this study is to validate the use of the Chiropractic Students' Sport Questionnaire in terms of gathering information from participants in various sporting events. However due to the limitations of this study the participants will only be defined as those participating in cycling, hence the use of a slightly modified questionnaire.

The validation of the questionnaire is a two-step process, the first being the collection of the data with the unvalidated questionnaire and the second being critical analysis of the information in terms of what actually happens in the fraternity of cycling.

Discussions will focus on the main trends that have been found through the analysis of the data. You are at any point permitted to disagree with the findings if such is the case, however please give your reasons for disagreement as this will help in the research process.

Your participation in this study is much appreciated and you are assured that your comments and contributions to the discussion will be kept confidential. The results of the discussion will only be used for research purposes.

If you have any further questions please feel free to contact either my supervisor/ co-supervisor or myself.

Barry Mills

**APPENDIX B: CONFIDENTIALITY STATEMENT DECLARATION – FOCUS GROUP**

**IMPORTANT NOTICE: THIS FORM IS TO BE READ AND FILLED IN BY EVERY MEMBER PARTICIPATING IN THE FOCUS GROUP, BEFORE THE FOCUS GROUP MEETING CONVENES.**

**CONFIDENTIALITY STATEMENT – FOCUS GROUP  
DECLARATION**

1. All information contained in the research documents and any information discussed during the focus group meeting will be kept private confidential. This is especially binding to any information that may identify any of the participants in the research process.
2. The patient files will be coded and kept anonymous in the research process.
3. None of the information shall be communicated to any other individual or organization outside of this specific focus group as to the decisions of this focus group.
4. The information from this focus group will be made public in terms of a journal publication, which will in no way identify any participants of this research.

Once this form has been read and agreed to, please fill in the appropriate information below and sign to acknowledge agreement.

**Please Print in block letters:**

Focus Group Member: \_\_\_\_\_ Signature: \_\_\_\_\_

Witness Name: \_\_\_\_\_ Signature: \_\_\_\_\_

Researcher's Name: \_\_\_\_\_ Signature: \_\_\_\_\_

Supervisor's /  
Co-supervisor's Name: \_\_\_\_\_ Signature: \_\_\_\_\_

## APPENDIX C:

## INFORMED CONSENT FORM – FOCUS GROUP

**INFORMED CONSENT FORM**

(TO BE COMPLETED BY THE PARTICIPANTS OF THE FOCUS GROUP)

DATE: \_\_\_\_\_

**TITLE OF RESEARCH PROJECT: An Investigation to establish an injury profile in South African cyclists and it's association to bicycle set-up.**

**NAME OF SUPERVISOR: Dr. C.M. Korporaal**

**NAME OF CO-SUPERVISOR: Dr. A. Jones**

**NAME OF RESEARCH STUDENT: Barry Mills**

**Please circle the appropriate answer**

- |  | <b>YES /NO</b> |
|--|----------------|
| 1. Have you read the research information sheet?   | Yes No         |
| 2. Have you had an opportunity to ask questions regarding this study?  | Yes No         |
| 3. Have you received satisfactory answers to your questions?   | Yes No         |
| 4. Have you had an opportunity to discuss this study?  | Yes No         |
| 5. Have you received enough information about this study?  | Yes No         |
| 6. Do you understand the implications of your involvement in this study?   | Yes No         |
| 7. Do you understand that you are free to  |                |
| a) Withdraw from this study at any time?   | Yes No         |
| b) Withdraw from the study at any time, without reasons given  | Yes No         |
| c) Withdraw from the study at any time without affecting your future<br>Health care or relationship with the Chiropractic day clinic at the Durban<br>Institute of Technology. | Yes No         |
| 8. Do you agree to voluntarily participate in this study   | Yes No         |
| 9. Who have you spoken to regarding this study?  |                |

**If you have answered NO to any of the above, please obtain the necessary information from the researcher and / or supervisor before signing. Thank You.**

**Please Print in block letters:**

Focus Group Member: \_\_\_\_\_ Signature: \_\_\_\_\_

Witness Name: \_\_\_\_\_ Signature: \_\_\_\_\_

Researcher's Name: \_\_\_\_\_ Signature: \_\_\_\_\_

Supervisor's /Co-supervisor's Name: \_\_\_\_\_ Signature: \_\_\_\_\_



**APPENDIX E: QUESTIONNAIRE (Dr. C.M. Korporaal)****EVENT NAME / LEVEL / AGE GROUPING / TURF TYPE****DATE (e.g.):** \_\_\_\_\_NAME: \_\_\_\_\_ AGE: \_\_\_\_\_ TEAM: \_\_\_\_\_  
Player Ump Coach Manager Official Med Team Other: \_\_\_\_\_

PLAYER POSITION: \_\_\_\_\_

ETHNICITY: W B IN OTHER: \_\_\_\_\_

YRS EXPERIENCE: (Professional) \_\_\_\_\_ (Amateur) \_\_\_\_\_

NO. OF GAMES PARTICIPATED IN THIS TOURNAMENT: \_\_\_\_\_

<b>NEW PATIENT</b>	<b>REPEAT PATIENT</b>	<b>NEW CONDITION</b>	<b>CONTINUATION OF CARE</b>
--------------------	-----------------------	----------------------	-----------------------------

**PREVIOUS TREATMENT:** \_\_\_\_\_**LOCATION:**

HEAD/CONCUSSION

ANT THIGH COMPART.

SHOULDER

NECK

POST THIGH COMPART.

ELBOW

THORACIC

MEDIAL THIGH COMPART.

FOREARM

LOW BACK

KNEE

WRIST

RIBS

SHIN/CALF

HAND

HIP

ANKLE

FINGERS

BUTTOCKS

FOOT

**MECHANISM OF INJURY:****DURING****1.PREVIOUS COMPETITION****2.PRACTICE****3.COMPETITION**

RUNNING

SPRINTING

SIDE STEPPING

COLLIDING(PERSON)

COLLIDING(STICK)

COLLIDING(BALL)

SLIDING

TACKLING

**HAVE YOU INJURED THE AREA BEFORE? YES NO WHEN? \_\_\_\_\_ DID****IT CAUSE YOU TO LEAVE THE GAME THEN? YES NO****DID THE INJURY CAUSE YOU TO LEAVE THE GAME NOW? YES NO****CLINICAL IMPRESSIONS:****ACUTE****CHRONIC**

CONTUSION

LACERATION

BLISTER

HEAT EXHAUSTION

SPRAIN

STRAIN

DISLOCATION

FRACTURE

MYOFASCIAL (SPECIFY) \_\_\_\_\_

C/FACET

T/FACET

L/FACET

SI SYNDROME

TENDINITIS

PFPS

SYSTEMIC DIS

NEUROLOGICAL

CIRCULATORY

DOMS

JOINT DYSFUNCTION: \_\_\_\_\_

GENERAL MUSCLE TIGHTNESS

SUPRATENTORIAL

OTHER: \_\_\_\_\_

**TREATMENT**

MANIPULATION: \_\_\_\_\_

MASSAGE

MOBILISATION: \_\_\_\_\_

ISCHEMIC COMP.

FASCIAL RELEASE

NEEDLING

PNF

STATIC STRETCH

STRAPPING

ICE

EXERCISES

CROSS FRICTION

MODALITY (SPECIFY): \_\_\_\_\_

**CONTINUATION OF PLAY****\*RESTRICTED:** \_\_\_\_\_**\*HOSPITAL:** YES NO

WHY? \_\_\_\_\_

HOW LONG? \_\_\_\_\_

**REPORTABLE:** YES NO (any \* means reportable)**TREATMENT BY :**

DC (SIGN) \_\_\_\_\_

DC STUDENT (NAME) \_\_\_\_\_

FOR RECOMMENDATIONS PLEASE SEE REVERSE

**RECOMMENDATIONS MADE TO THE PLAYER / COACH IN RESPECT OF THE PLAYERS  
CONDITION:**

---

---

---

---

---

---

## APPENDIX F: THE FOCUS GROUP DISCUSSION

### TRANSCRIPT OF THE TAPE RECORDINGS

---

Okay, take us through this.

No, you have to take yourself through it, basically the first 3 pages you have to read through them and then sign them off. The whole thing tonight is that the last 3 pages is a questionnaire that I am doing. The previous page is the one Miss X did and I've adapted mine from her research.

Okay.

With the stuff I have changed, we will look at the whole thing and see if there is any ambiguity of questions or something that doesn't follow over from anything like that. If you find anything you think I should include just shout out and say... This is the story.. if you find anything you don't like, say why you don't like it. Okay, so that we can give a solution to it. Once everybody has read the whole thing and knows exactly what is going on then we can basically start ... I'll give everyone 5 minutes to look through the whole thing and we can go from there.

If you need any information on the Confidentiality Statement and the Consent Form or anything else to do with the whole thing, just shout. All it is, is the Confidentially Statement acknowledging that all the information gathered is confidential and will be kept within the research itself and the Consent Form is that you give me permission to use any of the information as discussed here in my research...Once you have read through please sign and ask any questions or what ever.

Everyone here is obviously wondering whose signatures are going to be used as a focus group member? Just sign in the space there (indicated)

Okay... Any questions so far?...Still reading? ... Still reading!

Can I ask a question?

Yes.

Would it not be a good idea to add in the number of years experience, I know you have said 'hours per week on the bike' and also 'how young the cyclist was when they first, started cycling'

Sure.

Also something on their first overuse injury, especially concerning children's growth and development patterns'

Okay.

Has anybody got any questions before we go onto the questionnaire itself, like goal and consent and all the rest of it? Has everyone signed and given consent?

Would gender not also be important? ... Good point, that's cool.

What about height and weight comparisons?

Okay.

What about height of a person, as a person being 1.9 would use a different size frame and to compare crank sizes as well? ... Audio not clear... also consider brake type... Okay, I'll write that in so we can make a comparison between the two....

Also cleats, we need to put in a definition here ... audio not clear ... because an oke could be riding with a small cleat on the road say for half-an-hour and then complain of foot pains ... audio not clear .....

Okay we can do that and write it

in .

Lets start at the top of the questionnaire ... with name and age everybody is happy with that. Everybody happy with team cyclist and all the rest of it, also ethnicity, just tick who the person is ... Miss Y suggested we consider years of experience, should we break this up between professional, amateur and novice or just years of experience?.... Just years, when they first started putting on mileage.

Carrying on down ... it was mentioned that I should bring the patient care and previous treatment up to the top of the form so that we can separate bicycle and patient.



I will do that, so obviously there I will bring in the patient care or any treatment, if they have had any and then I will go onto the bicycle type and all the rest of it from there. Everybody happy, with that?

Yes.

The next thing is the bicycle type, and all the rest of it from there. This is divided into racers, mountain bikes, mountain bike/ road or hybrids, the reason for this is, I have 3 groups, which I am dividing up, do you guys think I should further divide, shout?

No.

Frame size, every body happy with frame size, obviously with a mountain bike we will use small, medium or large or with a racer we will use centimetres.

Okay, so for racer we will use small, medium and large and racer centimetres.

Frame material, mechanics and the rest... I have included 4 types, aluminum, chrome-moly, carbon fibre and titanium, anything else you think I should include in there?

No.

The next is shock or fork, why I have to divide is that if it is a racer you will have to go with fork and with a mountain bike a shock. The different types of material used in the fork are aluminum, chrome moly, carbon fibre and titanium. All happy there?

Yes.

Going back to Mr. B question earlier on pedal type, SPD versus small cleat or larger cleat, should I also include floating cleats on that one? Yes The more information we can get on the bike the better the cyclist can handle the down hills. Mr. A , happy, any additional comments here? No ...Okay that's pedal type done.

Tyre size and tyre pressures, is obviously important from my aspect because I think that will be important in the research on injuries as well, I don't know if you guys think I should include racer size, pressures, what do u think? I think tyre pressure plays a big part in bike set up; tyre pressures should conform to tyre size bearing in mind that mountain bike pressures differ from racers.... Also bear in mind; will the patient always know exactly what you are asking? The patient might not know, but he can work it out because 99% of bikes use 26 inch tyres @ a pressure of 3.5 –

4.5 bars and 700c tyres are 8 – 10 bars. So if a rider goes down hill on a mountain bike he must be aware of what his bikes pressure range is. The cyclist must record his bike details and research document must specify what the pressure range is...Ok...Happy with tyre sizes and pressures?

The next section is Patient Care; this is where I had to change the questionnaire around a bit. Patient care is whether the patient is a new patient; repeat patient, new conditions or continuation of care, this just tells you about the patient. New patients will just tick and if it is a continuation of care which probably won't be in my study but this also going to be used in future for sport Chiro events so that is why we are looking at the whole thing including repeat patients and new conditions as sometimes events take place over more than one day. Previous treatments will include physio, x-rays and anything of that nature, and will help with my inclusion or exclusion criteria as well. Okay, that will give an indication as to whether a patient should be included or excluded in the study.

Okay

Sorry Barry, just to interrupt you, surely in any study considering all factors there should never be any inclusion or exclusion criteria, Ja, ja sure. There should never be any reason that a person should not be included in the study.

Okay, except if a person has already got acute injuries now not a chronic type picture. Even so. Even so, as you want to know whether the injuries irrespective of what it is, is related to the bike set-up ...Cool... If that makes sense...Yes it does.

The next page is more on Locations as the heading says: where the injury is and the clinical presentation. This section has been divided up from head to toe; if you look down the left hand column is going down the body and then down to the foot on the right side column. If there is any ambiguity, I know I have to change the thigh compartment on the knee from anterior-front because I just believed that there might be some confusion with people not knowing the anterior, posterior, medial and lateral, compared to the front inner and outer for instance, so if everybody is happy with those, have a quick look through that to see whether you need me to include or exclude anything there... For parts of the body where you have left and right will noting that make a difference?

Yes, good idea, I didn't think of that, what I will do for example is say elbow I will just tick location and indicate whether it is left or right.

On the question of left and right would it make a difference to know which side is the more dominant in your patient?

Yes, it probably would, as it would show dominance of right hand or dominant leg that you would take off on.

In terms of posture would that make a difference of how the person actually rides the bicycle, as some people ride with their elbows down while others sit more up right? It does make a difference, it is more of a difference is the weight of the person, related to the bicycle set-up, puts the weight onto their arms? There is a way to measure this, you put a scale onto the front wheel and get the person to sit in their normal riding position, that gives you the balance of the bikes and gives you an idea as to whether the bike set up is correct or incorrect. In terms of the posture yes it does, but if they are riding an incorrect posture on their bikes then we will hopefully change that. And see if they are, that is the object of this study. I know for instance, on a racing bicycle you should have between 2 and 6 cm between your handle bars and the top of your saddle so that will come into it, ja.

Where are you going to collect that information? Where am I going to collect what information? Whether the handlebar is above or below saddle? That will be in the bicycle section, the bicycle will be assessed as well, okay, it is not in this section, this section is more about what injuries are being presented. When the assessment is complete I will give the patient a guide, for example, to say exactly what currently literature says the measurements between seat and handle bar should be, it will be up to the patient to decide whether they want to take the advice given or not. Some cyclists will say no, some cyclists will say they are happy riding in the position their seat is in and will not too happy to change. Mr. A is smiling as he rides his bike in a funny position. To take that point further, maybe there is a correlation between postural lack thereof and injury? Posture on or off the bike? On the bike...Okay... Irrespective of whether they are weight bearing or not weight bearing or irrespective of whether they have a funny posture or not ...surely, you will see this when you see the injury.

It should ideally correlate with the injury if the posture is the problem that is presented ... What should happen, is if a person is presenting with shoulder pain or whatever, we can assess what is showing in the current literature or what could be causing the pain. You need to generate this information for your research first, before you correlate your literature. That is where my literature review will come in and the document that I will be giving them based on the current literature that is out there. You have to for the South African context develop a profile of the cyclist. Ja... then once you have developed it, compare it to the international reports, this will become your literature report, so I wouldn't write something like past available literature may... says yes or no, as from a South African context we might ride our bicycle backwards for all you know, that they don't do in Scandinavia and this is where your literature is coming from, so you have to be very careful and throw out things that you assume are not going to correlate. Obviously that will come in at the end with your results when you analysis everything, surely?

You have to have it to analyse first, so you have to have it in your questionnaire, if it is something that the group deems as being relevant. For posture, how will I measure posture though, if I don't measure bicycle set-up with the person. Are they sitting upright, are they slouching? I know when I am tired I lean forward, or I try and sit upright, know what I mean, because my back is sore, I think it also depends on how you slouch over the handle bars, your handle bars could be the right height but if you slouch over them or you might have straight arms. I don't know how you would differentiate between the different grades of lying down, falling over your bars or sitting upright, Maybe consider asking the question, when I get tired do I change my posture and note that there is usually a change in posture at some point. This may sound like a silly question but would it be of any interest to know how many gears there are on the bike. In other words the more gears there are the more options there are to ease your ride. So basically what you are looking at is cadence? So we need to say do you spin, pedal wise or do you prefer gears? Ja. That would affect posture guaranteed, because if you are grinding or pushing a higher gear. Ja.

So under posture, I should include the difference between standing versus sitting, or does the cyclist prefer to spin or use gears?

Do you stand a lot or sit because a lot of guys just sit and that's it. Then they will suffer with their lower back. That will definitely come into it. Okay, anything else here?

What about the terrain ... That comes up under injuries.

Injuries, I will tick whether the injury was sustained at a previous competition, during training or during a competition, whether it was on road, off road, after climbing or after sprinting, I have included that if the injury was sustained during a training ride or during the race, we need to know where and at what range it occurred giving us an idea of the position, most cyclist will have this information as they use computers on their bikes.

Will fitness come into it, in a sense that somebody is not fit? That will all come in under patient information.

From a novice, what about falling off your bike, that I consider being a very good point, what about colliding with something like a tree or a car... Good question! I see your point in wanting to include this but I tried to exclude anything acute such equipment failure or somebody presenting after being hit by a car as that would be a totally different picture to chronic, however if they have had an accident before and it has bothered them for say how many years, for example an ankle injury or whatever. You would then include when or where it was. The person may not have gone for treatment.. Sure. So what did they do to compensate for what you are investigating or what did they do to rectify it? You would then need to get them to explain how they cope with the resultant injury and how they have adjusted their posture and cycling position... (Joked about wearing a 'hard-hat')

For stats purposes, do you not need to know, at what point was the injury sustained, I don't know!!, does not give you any idea where the injury was sustained. You may get a person riding 50 kms a week, which will be from point A to point B but he doesn't ride with a computer so he won't know where 25km is. So should I put in here estimate your kms? ... Put other ... maybe give a range, say 0 – 10 so that they can ballpark their range. Discussion followed on how to obtain this figure for stats purposes; working on +-kms of the course had been completed. Using a range from 0 – 150 kms going up in units of 10 kms, at the end of the study if a large number competed in a race over 150 kms that would be included.

While discussing the distance traveled before injury, what about including distance traveled per week on the bicycle irrespective of an injury? That is included in the first section, mileage per week and hours per week on bike. If I were answering this questionnaire, what happens if I rode a 50 km race and suffered an injury say at 11 – 20 kms but on my 100 km race it happened at 80 kms, how would I answer your question? At different distances it may occur at different stages. So what you are saying it depends on how you are pacing yourself... If it is a 100 k race it may have happened later... For example it may have happened in the first  $\frac{1}{4}$ , the second  $\frac{1}{4}$  or the third  $\frac{1}{4}$ , or doesn't it matter what the distance is as long as it is in relation to the degree or extent of the exercise. Should I include my range as 1 or should I say depending on mileage/distance travel did the injury occur at  $\frac{1}{4}$ ,  $\frac{1}{2}$  or  $\frac{3}{4}$  of the distance, how do I get around the problem? If somebody rides 150 kms and has an injury at 11 kms but another riding 20 kms sustains their injury at 11 -20 kms it actually happened at the same time for both of them but they are riding totally different distances. How do you reckon I record that then? Maybe break it down into  $\frac{1}{4}$ 's' otherwise be more specific by breaking down into the kms they are doing per week, when the injury happened or the chronic situation presented... Audio not clear ... Why don't we go mileage per week, mileage per training session and that would narrow it down there ...? Then he would be able to more easily answer the question.

Suggestion to add, profession and what other exercise is carried out, such as gym or other sports, which, could also influence any injuries or over training and do they suffer the same injury when partaking in other sport? Should I include cross training? No just put in 'other' training and specify other sports, and to explain, for example, if they do running do they have the same problem So Mark, would you be happy if we go with mileage per week, hours per week on bike, mileage per session and at what stage of the session was injury sustained. Maybe as well they could remember at what stage of a race the injury was sustained' as they would be taking part in many races so injuries could occur at different sections of the race. In this section there is no one answer, I don't know if everyone agrees? That is why I have put in previous competition and then training and competition, should I not bring that in so that I have got, previous competition where they can say they were injured at 11 kms and in another race it happened at whatever distance. We

also need to record the distance of the race. So should I just adjust my distances versus the top heading? Okay. So if a person had to tick say a previous competition and say after climbing, I would have to have two different ranges so or options for them to file in. Ja, then you wouldn't have to have say 20 blocks after everything, just say 20 or 100, 10 of 20. So you think I should take that range out? Yes and put in stage where it occurred over the total distance.

Barry, another option I am thinking of, would be for you to use something like your NRS scale where you would have a 10cm line and irrespective of what the total is at the end, take a percentage, at what point along the line did it cause a problem so you have at least one figure that you are dealing with you do it analogically? So my NRS won't be pain it will be for mileage? You could use it for both mileage and pain as you can take 2 separate readings, doing it this way you won't have to have to have different questions for the professional rider and the amateur. Okay Essentially, in my mind, if you taking the guy doing 80 kms in a 100 it will be roughly 80% on the line but a person doing at 10 of 20 that will be 50 so you will put it in the middle. Ja, okay, so rather I put in a scale and everyone can fill it in where they want. Yes, with a 10 cm line. Okay, so everybody happy with injuries? Yes

Clinical Presentation: has anyone got any questions on what's what, this is more my section, for me to complete as many of the people will not understand what the medical terms are when they come into play in this section, I will complete this from the information given by the patient. Any further inclusions, suggestions please. I note for instance that I do not have anything in on concussion, should I include that? Under fractures, should you not ask what? ... Will put in: Specify.

We also need to put in the left or right story in here!

Ja.

Also include acute and chronic... Okay.

Leg length, has been included as it is going to be one of the variable that you will find in patients. There are 2 important measurements, being Actual and Apparent; both are included as they are used on the clinical side of things.

Would it not be a good idea to include in-seam measurement? In-seam measurement!! You might have a guy who is 1.8 m tall, but has a short in-seam,

who is having problems with neck area because the bike is too short and he has a long torso? Sure. He is sitting upright on his bicycle, his legs are fine but his upper body is paining!!! This is where there could be some pressure as well. Is there anything else I should be measuring? Should we not also measure torso? We should consider doing all body lengths. All the measurements should go in the front section. I could divide it into cyclists, measurements and bicycle measurements. Do you measure torso in the shop as well? So you take the measurements from the top to? Audio unclear.

Another dumb question from the peanut gallery, what, about helmet, lack of helmets and protective clothing? All races that you ride, adopt the rule of 'no helmet, no ride'. If you ride with a team and go training on the road, they will 'swear you' and tell you to get off the road if you are not wearing a helmet. So it is a good point of view. Can you assume when one cyclist is going out alone for one day and he is not wearing a helmet that they will all do that? No, you cannot assume it, but if a person is presenting with a head injury or concussion should I now ask them whether they have a helmet? That would be a good idea. Or should we include a schedule of all protective clothing at the beginning? Yes

A discussion then followed about the different types of protective clothing that is worn by the different cyclists e.g. BMX riders, would wear knee guards, elbow guards etc. Mr. A are you wearing your elbow guards? Laughter

Just from a neurological point of view, the amount of protective clothing worn by a patient, if they go into an injury type situation they will have inherent more protection than somebody who doesn't wear it, so is the injury due to the lack of? Sure. So the main thing there is going to be the helmet and then we will go onto Andrews's number 8? And look at the rest of the stuff. We have kneepads and what other stuff? Knee pads, elbow pads, shin guards, ... audio unclear.. that will for your downhill guys as well? Yes. Just a question there, talking about downhill, should I include down hill as off-road or should I just go off-road and divide it into down hill and mountain bikes, or should I just put straight off-road and mountain bikes? Or do you think I should break it up into sections? You need to distinguish between mountain bike road and mountain bike off.



Now to put a spanner in the works, dual-suspension bikes, do I include dual-suspension bikes in here as well? Yes, I think you should include the dual-suspension bike. So we will also go with frames size as well. Mr. B explained how the suspension works something about the back shock and front but audio unclear

Anything else, just thinking...will it make any difference to know the brand name of the bike? Brand name, we can include it but obviously we don't want to include it in the study itself because we you open ourselves up to liability claims and all the rest of it. But what are the sizing differences? Why do you want to include brand names, because 7005 tubing is 7005 tubing and any one can make the bike? All the companies make the same bikes. They all use the same aluminum, the only difference is the way they weave the carbon fibre. Does it make any difference to the size? No, is doesn't make a difference to the size, all bikes come out in the same sizes, small, medium, large, 17, 19. Okay, fine then  
Happy with Clinical Presentation, obviously I must just include left and right and in fracture I must put in specify. Okay

Last page, leg length will go in with cyclist information as well as inseam measurement as well as torso measurement. Okay, everybody happy to move that across... Yes

Treatment: Doctors side, for my research purposes myself I will be using something called 'soap note' which is a chiropractic document. It is a subjective, objective assessment planning, exercise and education of the patient. Why I have included the treatment here is because this document I am hoping to use if we get into cycle races like Tour de Durban next year you can use this document you don't have to take a 'soap note' with you. But in my research I will be using a 'soap note'. This is more towards if we go to cycle races the doctor will be able to use this document as a quick reference paper, so that is why I have included that. Manipulation and immobilisation, and all the rest of it just read through it and ask questions, but this document contains much chiropractic terms please ask if you want to know more about the terms. Miss Y do you think I need to include anymore from the Chiro side? Do you think I have got most of the stuff?

You can't put too much in because it will depend on the injury. Ja. Sure. Down here I put in mobility specify, if you are going to have anything but I don't think you will. That's all from the Chiropractic side.

Recommendations made to the cyclist, this is for any recommendations, from using gloves, using helmets or anything like that, and including changing the set-up will be recorded in here. Cyclists for example, complain about pain in their hands, they can overcome this by increasing the size of the handlebar by using double wrap instead of single wrap, you have probably heard about this already. All that kind of stuff will be backed up by available literature, which I am going to give to them once they have been assessed so that will be recorded here as part of the whole study. Any other questions Miss X?

The only other thing that is going round in my mind on previous treatment I don't know what page it was one, do you want to specifically know who the health care provided was? Like doctor, physio, sangoma or self-health or whatever? Or did they use the 'self-help method' and how they sorted the problem out and whether it actually worked

How much further are you going to take this study in terms of cyclists, how do you know that what you have recommended to them is going to be beneficial to them? Is there any feed back there after regards to your recommendations as to whether your recommendations worked? Is there going to be any further follow up?

From my side my research is on what is presented to me on that day, the recommendation will be towards the injury like ice, stretching or whatever, once we assess the bicycle story and say the person riding the bike and it is too large, I will record that the bike was too large for them and what my recommendation was, for example that they need to ride a smaller bike. Economics wise, I cannot say that you must sell your bicycle because you mustn't have an extra large frame you should have a large frame. Can I ask you a question, I ride a bike and my saddle height is too low, and I am complaining of knee pain, I come to you and ask you to raise my saddle by 2 cms but that will makes my saddle height and my handle bars either too high or too low. 2 days later I am complaining of back pain, now what, why don't you transfer.....At one time?

The frame size is right, the saddle height needs to go up so why aren't you telling me that the handle bar must go up? It also becomes a bit of a problem like I went to this guy for help and this is what he did to me, but the pain went from my knee to my back. I do have information to back that up, they say that you shouldn't be increasing your saddle height by too much, you should only increase by 1cm every 6 weeks, which I will include in the document after the patient has been accessed and after you have had your first treatment. From my side of things if somebody from the Chiro department wants to do a follow up study now, it opens the doors up for them and this is where I suggest at the end of it, that there is an option now to do a follow up study and whether my advise that was given was useful or not. From my side of things I am just looking at what they present straight away on the day and basically my study ends there. They are benefiting in terms of they are getting advise and if they take that advise it is entirely up to them. Legally I can't say to them they must sell their bike and go and buy a 5 track or a giant of what ever, I can't do that. My research is just basically a survey of what injuries you are getting and if your bicycle is the wrong size in terms of your in-seam measurement, your torso length or... correlation between the cyclist and the bike frame itself, if they are going to have the incorrect size, using the literature that is out there, then we can investigate that there is a problem with bicycle fitment.

This is where my study ends, I would like to have gone in further but in terms of my research, it will take too long to do it and it will be too expensive as I have a limit of just R3000 unfortunately.

Is there any way that you can get the cyclist to bring their bikes to the clinic and you could assess them? A person may think he has the right size wheel and he thinks that his bike is the right size? I have spoken to Mr. E Cycles, and how it is going to work is that I am going to go there and assess the patient, then if they want to bring their bike, I cannot force someone to bring their bike in, if it gets stolen and I will be responsible for it. We will assess the bicycle there and then if they want it, straight after they have been accessed in terms of new patient assessment, okay. Once they have done that then they are entitled to a free treatment here at the clinic.

So they are basically getting, is a whole physical case history, regional, everything that gets included, so that is why they are treated as new patients from the chiropractic side. So everything that is done in the clinic from the Chiropractic side will be covered in this study. From their side if they want advise on bicycle set-up and fitment if they want.

The patient must bear in mind that with the correct set-up they may encounter some stiffness if they do it too quickly, which will be explained to them on the document with all the advise. When they visit the clinic they will be treated for the symptom that they presented with at their assessment, so obviously they cannot wait too long between the assessment and a free treatment, which from the clinic's point of view will be a follow-up patient. If they encounter any problems after the bike has been set-up this could this be looked at when they visit the clinic? The cyclist must bear in mind that it takes up to 6 weeks after the set-up has been changed, so they may encounter stiffness. They will be given a comprehensive document to assist them. From my side of things I am giving each patient a 'thank you' but if somebody wants to take the research further they are welcome to do that and can look at stretching programs and opens up doors to many more people so this is actually pioneer research for anyone who wants to look further into cycling injury research. I am just trying to establish what over use injury problems South African cyclist are getting and what injuries are common. I could cover the acute side... my research concentrates on the chronic side of things.

Outside of the cycling fraternity, I did my research on hockey and if you read literature from around the world the biggest thing they reckon is that hockey players suffer mostly with ankle sprain but on my list it only came up 10<sup>th</sup>. You need to be very careful in a research like this to make an assumption, the cause or a lack there of, as overseas studies that may have already done that and come out with a skewed perspective of what the injury was actually due to.

Going back to treatment, I should actually put that as past treatment not just treatment, so if the person has been treated I can ask them, as my 'soap notes' will be recording what problems they have now. So if a patient takes part in a race say

over 4 days, if the person comes to me for treatment on Monday for an injury, then on Tuesday I can look it up and say I have been for my previous treatment and the doctor treating them will know that they have been treated for something. The doctor treating them can look at the 'soap notes' and will be able to see what treatment has been given and then do the follow up.

Why do you want to make the previous treatment part of your 'soap notes'? You can develop your questionnaire after you have done your research you don't have to do it beforehand. If that is what you are saying Miss Y? Yes

So what I am going to do now, I will change my treatment to past treatment from your side of things, but in my research itself I will include the 'soap notes' results. Okay, is that a 100 %?

We are valuating this document as if it was going to be used at a race, so we need to record both past and current treatment, possibly on separate pages. Previous treatment would be recorded here, whether it was Chiro or other. What I was saying is, say you have just ridden, and I come to you as the chiropractor, some people may have been the previous week, to a physiotherapist and they may have had the exact same thing. Do I include that? You have this form, so just put in specify, as you don't want to do it twice. Okay, sure. So should I rather take out the past treatment and leave it as treatment? Yes, as it does become past treatment as time marches on. Ja. And obviously for my research itself I will leave out the treatment and do 'soap notes'? Yes, Okay

Suggestion, how about adding in shoulder width as a measurement?

I had a discussion about this the other day, of why shoulder width in relation to handle bar length is relevant. . Audio unclear ... as 99% of cyclists don't know what their handle bar width is. So should we just measure shoulder width and not handle bar width, or must I do both shoulder width and handlebar width? Ja. So your suggestion is that we should have everyone bring in his or her actual bike for measurements? Yes, this would be a pre-requisite ... but no one carries a blue print of his or her bicycle. Any further suggestions or questions? Are we pretty happy?

Ultimately, if you had to fill in the first part of the questionnaire would you understand what you were being asked?

Yes

Everybody happy? Has everybody signed in all the necessary spaces, as I have to take all the documentation back?

Okay, thanks everybody, I have plenty of homework to do. I must admit it is quite a mission to try and work out what to include and with your research you know where you want to go but other people look at it differently. One thing I wanted to know was what happens if a person has different arm lengths but Mr. D said the cyclist would just adjust his body accordingly because to measure arm length is another story. So maybe the dominant side will take over. If everybody's happy please eat the rest of the food so that I don't get it for breakfast. Thank You

**APPENDIX G: CYCLISTS' QUESTIONNAIRE**  
**QUESTIONNAIRE (Modified from Korporaal; 2002)**

**PATIENT INFORMATION:**

NAME: \_\_\_\_\_  
 AGE: \_\_\_\_\_  
 OCCUPATION: \_\_\_\_\_  
 GENDER: Male (1) \_\_\_\_\_ Female (2)  
 HEIGHT: \_\_\_\_\_ cm  
 WEIGHT: \_\_\_\_\_ kg  
 LEVEL OF CYCLIST: Amateur 1  
 Professional 2  
 YEARS EXPERIENCE CYCLING? \_\_\_\_\_ Years

CROSS TRAINING? YES (1) / NO (2)  
 CORE STABILITY EXERCISES? YES (1) / NO (2)

AVERAGE MILAGE PER WEEK? \_\_\_\_\_ Km/week  
 AVERAGE MILAGE PER SESSION? \_\_\_\_\_ Km/session  
 AVERAGE HOURS PER WEEK ON BIKE? \_\_\_\_\_ Hrs/week  
 AVERAGE HOURS PER SESSION ON BIKE? \_\_\_\_\_ Hrs /session  
 DOMINANT HAND L (1) / R (2)  
 POSTURE ON BIKE?  
 Upright (1) sit back (2) bent forward (3)

**PROTECTIVE GEAR:**

	YES (1)	NO (2)
Helmet		
Gloves		
Sunglasses		
Padded shorts		

**PATIENT CARE:**

New condition 1  
 Continuation of care 2

**PREVIOUS INJURY?**

- 1) Any orthopedic surgery? YES 1 NO 2  
 2) Previous muscle injury? YES 1 NO 2  
 3) Any fractures? YES 1 NO 2  
 4) Connective tissue injuries (tendons/ligaments) YES 1 NO 2  
 5) Past sporting history? RUNNER 1  
     SWIMMER 2  
     TRI-ATHLETE 3  
     RACQUET SPORTS 4  
     RUGBY 5  
     SOCCER 6  
     PADDLING 7  
     OTHER (please specify \_\_\_\_\_) 8
- 5) Injury (ies) not related to cycling:(please specify) \_\_\_\_\_
- 

**PATIENT ASSESSMENT****LEG LENGTH:**

ACTUAL: Left - \_\_\_\_\_ Right - \_\_\_\_\_  
 APPARENT: Left - \_\_\_\_\_ Right - \_\_\_\_\_

**SHOULDER WIDTH:** \_\_\_\_\_ cm

(From acromio-clavicular joint to acromio-clavicular joint)

**INSEAM MEASUREMENT:** \_\_\_\_\_ cm

**TORSO MEASUREMENT:** \_\_\_\_\_ cm

(Sternum to pubic symphysis)

**LOCATION OF INJURY RELATED TO CYCLING:**

HEAD / CONCUSSION		1
NECK	L / R	Upper /Middle /Lower
SHOULDER	L / R	2, 3, 4, 5,6
ELBOW	L / R	7, 8
FOREARM	L / R	9, 10
WRIST	L / R	11,12
HAND	L / R	13, 14
THUMB	L /R	15,16
FINGERS	L /R	17,18
THORACIC	L / R 2 / 3 / 4 / 5	19,20,21,22,23,24
RIBS	L / R	25,26
LOW BACK	L / R	27,28
BUTTOCKS	L / R	29,30
		31,32



**THIGH COMPARTMENT:**

Anterior / Front	L / R	33,34
Medial / Inner	L / R	35,36
Lateral / Outer	L / R	37,38
Posterior / Back	L / R	39,40
<b>KNEE:</b>		
Anterior / front	L / R	41,42
Medial / Inner	L / R	43,44
Lateral / Outer	L / R	45,46
Posterior / Back	L / R	47,48
SHIN / CALF	L / R	49,50
ANKLE	L / R	51,52
FOOT	L / R	53/54

**MECHANISMS OF INJURY:**

COMPETITION	1
TRAINING	2
ROAD	3
DURING CLIMB/IMMEDIATELY AFTER CLIMB / 10 MINUTES AFTER CLIMB / 1 HOUR AFTER CLIMB / NEXT DAY	5,6,7,8,9
DURING SPRINTING / IMMEDIATELY AFTER SPRINTING / 10 MINUTES AFTER SPRINTING / 1 HOUR AFTER SPRINTING / NEXT DAY	10,11,12,13,14
MOTOR VEHICLE ACCIDENT	15
FALLS	16
UNINTENTIONAL PARTIAL DISMOUNT	17
PATIENT COMPENSATION (do you change your cycling style as a result of your injury or as you gets tired?)	
• Sit more	18
• Stand less	19
• Shift weight back/forwards while seated	20/21
DO YOU PUSH BIG GEARS OR SPIN? _____	22/23
WHAT % of hills do you stand on?	
0-25% 26-50% 51-75% 76-100%	24,25,26,27

**CLINICAL PRESENTATION:**

ACUTE	1
CHRONIC	2
CONTUSION	1
LACERATION	2
BLISTER	3
HEAT STROKE	4
EXHAUSTION	5
SPRAIN	6
STRAIN	7
DISLOCATION	8
C / FACET	9
T/FACET	10
L / FACET	11
SI SYNDROME	12
PATELLO-FEMORAL PAIN SYNDROME	13
TENDONITIS	14
CIRCULATORY	15
JOINT DYSFUNCTION	16
NEUROLOGICAL	17
MYOFASCIAL: specify	
Neck: _____	18
Upper extremity: _____	19
Lower extremity: _____	20
Upper back: _____	21
Middleback: _____	22
Lower back: _____	23
FRACTURE specify: _____	24
OTHER, Specify: _____	25

**BICYCLE INFORMATION**

BIKE-TYPE:	1) Racer (double / triple chain ring / flat bars)	1(2,3,4)
	2) Mountain Bike (Hard tail / Dual suspension)	5(6,7)
	3) Mountain Bike (Road-slicks on / Hybrid-racer gearing)	8(9,10)
FRAME SIZE:	S (14-16" or 48-51cm)	1
	M (16-17" or 50-54cm)	2
	L (17-18" or 53-57cm)	3
	XL (19-21" or 56 –60cm)	4
	XXL (21" plus or 60cm plus)	5
FRAME MATERIAL:	Aluminum	1
	Chrome-moly	2
	Carbon- fibre	3
	Titanium	4
TYPE OF SADDLE:	1) Gel seat	1
	2) Cut-out	2
	3) Carbon Fibre	3
	4) Wide Back	4
	5) Narrow Back	5
	6) Woman Specific	6
SEAT POSITION:	1) forward	1
	2) Centre of seat post	2
	3) Back	3
DISTANCE BETWEEN BOTTOM BRACKET TO TOP OF SEAT (measured from the centre of the bottom bracket to a point on top of the seat directly above the seat post) _____ cm		
HANDLE BAR WIDTH _____ cm		
FORK:	Aluminium	1
	Chrome-moly	2
	Carbon-fibre	3
	Titanium	4
SHOCK TRAVEL:	_____ cm	
SHOCK SET-UP?	Hard (1) / Soft (2)	
PEDAL TYPE:	Cleats	
	Floating	1
	Small	2
	Large	3
	SPD	4
	Cages	5
	Platform pedals	6
TYRE SIZE:	_____ inch	
TYRE PRESSURE:	_____ k.p.a (measured with pressure gauge)	
CRANK LENGTH?	_____ mm	
STEM LENGTH AND ANGULATION?	_____ degrees / mm	
LENGTH OF TOP-TUBE:	_____ cm	

---

**APPENDIX H: CASE HISTORY**

**DURBAN INSTITUTE OF TECHNOLOGY**  
**CHIROPRACTIC DAY CLINIC**  
**CASE HISTORY**

Patient: ..... Date: .....

File # : ..... Age : .....

Sex : ..... Occupation: .....

Intern : ..... Signature: .....

**FOR CLINICIANS USE ONLY:**

Initial visit

Clinician: ..... Signature :

<b>Case History:</b>
----------------------

Examination:

Previous: ..... Current: .....

X-Ray Studies:

Previous: ..... Current: .....

Clinical Path. lab:

Previous: ..... Current: .....

**Case Status:**

PTT:	Signature:	Date:
------	------------	-------

<b>CONDITIONAL:</b>	
Reason for Conditional:	
Signature:	Date:

Conditions met in Visit No:	Signed into PTT:	Date:
-----------------------------	------------------	-------

Signed off:	Date:
-------------	-------

**Intern's Case History:**

1. **Source of History:**
2. **Chief Complaint : (patient's own words):**
3. **Present Illness:**

	<b>Complaint 1</b>	<b>Complaint 2</b>
▶ Location		
▶ Onset : Initial:		
Recent:		
▶ Cause:		
▶ Duration		
▶ Frequency		
▶ Pain (Character)		
▶ Progression		
▶ Aggravating Factors		
▶ Relieving Factors		
▶ Associated S & S		
▶ Previous Occurrences		
▶ Past Treatment		
▶ <b>Outcome:</b>		

4. **Other Complaints:**

5. **Past Medical History:**

- ▶ General Health Status
- ▶ Childhood Illnesses
- ▶ Adult Illnesses
- ▶ Psychiatric Illnesses
- ▶ Accidents/Injuries
- ▶ Surgery
- ▶ Hospitalizations

**6. Current health status and life-style:**

- ▶ Allergies
- ▶ Immunizations
- ▶ Screening Tests incl. xrays
  
- ▶ Environmental Hazards (Home, School, Work)
- ▶ Exercise and Leisure
- ▶ Sleep Patterns
- ▶ Diet
- ▶ Current Medication  
Analgesics/week:
  - ▶ Tobacco
  - ▶ Alcohol
  - ▶ Social Drugs

**7. Immediate Family Medical History:**

- ▶ Age
- ▶ Health
- ▶ Cause of Death
- ▶ DM
- ▶ Heart Disease
- ▶ TB
- ▶ Stroke
- ▶ Kidney Disease
- ▶ CA
- ▶ Arthritis
- ▶ Anaemia
- ▶ Headaches
- ▶ Thyroid Disease
- ▶ Epilepsy
- ▶ Mental Illness
- ▶ Alcoholism
- ▶ Drug Addiction
- ▶ Other

**8. Psychosocial history:**

- ▶ Home Situation and daily life
- ▶ Important experiences
- ▶ Religious Beliefs

**9. Review of Systems:**

- ▶ General
- ▶ Skin
- ▶ Head
- ▶ Eyes
- ▶ Ears
- ▶ Nose/Sinuses
- ▶ Mouth/Throat
- ▶ Neck
- ▶ Breasts
- ▶ Respiratory
- ▶ Cardiac
- ▶ Gastro-intestinal
- ▶ Urinary
- ▶ Genital
- ▶ Vascular
- ▶ Musculoskeletal
- ▶ Neurologic
- ▶ Haematologic
- ▶ Endocrine
- ▶ Psychiatric

## APPENDIX I: PHYSICAL

## DURBAN INSTITUTE OF TECHNOLOGY

22/10/2002

PHYSICAL EXAMINATION  
SENIOR & RESEARCH

Patient: \_\_\_\_\_ File#: \_\_\_\_\_ Date: \_\_\_\_\_  
 Student: \_\_\_\_\_ Signature: \_\_\_\_\_

## VITALS

Pulse rate			Respiratory rate	
Blood pressure	R	L	Medication if hypertensive:	
Temperature			Height	
Weight:	Any recent change Y/N	If Yes : how much gain/loss		Over what period

## GENERAL EXAMINATION

General Impression	
Skin	
Jaundice	
Pallor	
Clubbing	
Cyanosis (Central/Peripheral)	
Oedema	
Lymph nodes - Head and neck	
- Axillary	
- Epitrochlear	
- Inguinal	
Pulses	
Urinalysis	

## SYSTEM SPECIFIC EXAMINATION

## CARDIOVASCULAR EXAMINATION

## RESPIRATORY EXAMINATION

## ABDOMINAL EXAMINATION

## COMMENTS

NEUROLOGICAL EXAMINATION: See regionals

Clinician: \_\_\_\_\_ Signature: \_\_\_\_\_



**APPENDIX J:** REGIONAL (For the sake of brevity these have been left out but are available)

**APPENDIX K:** S.O.A.P.E. NOTE

**DURBAN INSTITUTE OF TECHNOLOGY**

<i>Patient Name:</i>		<i>File #:</i>	<i>Page:</i>
<i>Date:</i>	<i>Visit:</i>	<i>Intern:</i>	<i>Signature:</i>
<i>Attending Clinician:</i>			
<i>S:</i> Numerical Pain Rating Scale (Patient) Least 0 1 2 3 4 5 6 7 8 9 10 Worst	<i>Intern Rating</i>	<i>A:</i>	
	<input type="checkbox"/>		
<i>O:</i>		<i>P:</i>	
		<i>E:</i>	
<i>Special attention to:</i>	<i>Next appointment:</i>		
<i>Date:</i>	<i>Visit:</i>	<i>Intern:</i>	<i>Signature:</i>
<i>Attending Clinician:</i>			
<i>S:</i> Numerical Pain Rating Scale (Patient) Least 0 1 2 3 4 5 6 7 8 9 10 Worst	<i>Intern Rating</i>	<i>A:</i>	
	<input type="checkbox"/>		
<i>O:</i>		<i>P:</i>	
		<i>E:</i>	
<i>Special attention to:</i>	<i>Next appointment:</i>		
<i>Date:</i>	<i>Visit:</i>	<i>Intern:</i>	<i>Signature:</i>
<i>Attending Clinician:</i>			
<i>S:</i> Numerical Pain Rating Scale (Patient) Least 0 1 2 3 4 5 6 7 8 9 10 Worst	<i>Intern Rating</i>	<i>A:</i>	
	<input type="checkbox"/>		
<i>O:</i>		<i>P:</i>	
		<i>E:</i>	
<i>Special attention to:</i>	<i>Next appointment:</i>		

**Are you older than  
18, riding 60km/week on a racer  
or mountain bike on road**

**Suffering from**

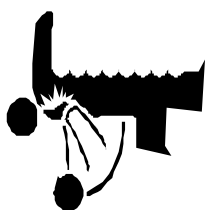

**Injuries**



**related to cycling**

**Research is currently being carried  
out at the Durban Institute of  
Technology**

**Chiropractic Day Clinic**

**FREE ASSESSMENT**

**AND TREATMENT**

**For those who qualify  
to take part in this study**

**For more information contact Barry  
on 204 2205 / 2512 or 0824455820**

**APPENDIX M: Letter of Information****LETTER OF INFORMATION**

Dear Participant.

Welcome to my research study. This study aims to investigate the injuries that cyclists develop over time relating to time spent on a bicycle in relationship to type of bicycle and bicycle set-up.

**Title of study: An Investigation to establish an injury profile in South African cyclists and it's association to bicycle set-up.**

**Supervisors:** Dr. C.M. Korporaal 031 2042205  
Dr. A. Jones 031 2042205(WEDNESDAYS)

**Research student:** Barry Mills 0824455820 /031-2042205

**Purpose of the study:** The purpose of this study is to establish what injuries cyclists develop over time relating to time spent on a bicycle in relationship to type of bicycle and bicycle set-up. One Hundred and fifty cyclists will participate in this study, fifty female road cyclists, fifty male road cyclists, twenty-five male and twenty-five female mountain bikers on the road.

**Procedure:** The two free consultations will take place at The Durban Institute of Technology's Chiropractic Day Clinic consisting of:

- a) One free Initial visit-case history, physical, regional questionnaire and a guideline to injury free cycling.
- b) One free treatment for the injury diagnosed in the initial visit. Should you require further treatments these will be charged at 6<sup>th</sup> year Chiropractic rates.

**Risks/Discomfort:** Patients may feel slight stiffness related to treatment and possible changes in bicycle set-up.

**Benefits:** Your contribution to this study, by volunteering to partake, will help us as Chiropractors to build on our knowledge. This will benefit you as a patient in the long run as we will be able to provide you with more effective health care in the future. On completion of the initial visit you will receive one free treatment for the injury diagnosed.

**New findings:** You will be made aware of any new findings during the course of this study.

**Reasons why you may be withdrawn from this study without your consent:**

You may be removed from participating in this study without your consent for the following reasons: a) If you are unable to attend your follow-up treatment

- b) If you sustain an acute injury due to an accident or equipment failure, etc.

- c) If you change any lifestyle habits during your participation in this study that may effect the outcome of this research (e.g. medication or treatment)

AS A VOLUNTARY PARTICIPANT IN THIS RESEARCH STUDY, YOU ARE FREE TO WITHDRAW FROM THE STUDY AT ANY TIME, WITHOUT GIVING REASON.

**Remuneration:** You will not receive a travel allowance in order to attend your appointment at the Chiropractic Day Clinic.

**Cost of the study:** Participants in this study will receive one initial consultation and one follow-up free of charge there after further visits will be charged at 6<sup>th</sup> year Chiropractic rates.

**Confidentiality:** All patient information is confidential. The results from this study will be used for research purposes only. Only the individuals that are directly involved in this study (Dr. C.M. Korporaal, Dr, A Jones and myself) will be allowed access to these records.

**Persons to contact should you have any problems or questions:**

Should you have any questions that you would prefer being answered by an independent individual, feel free to contact my supervisors on the above numbers. If you are not satisfied with a particular area of this study feel free to forward any concerns to the D urban Institute of Technology Research and Ethics Committee. Thank you for participating in my research study. Wishing you many pain free hours of safe cycling.

Barry Mills  
(6<sup>th</sup> year Chiropractic Intern)

Dr. C.M. Korporaal  
(Supervisor)  
M.Tech: Chiro, CCFC,  
CCSP, ICSSD

Dr. A Jones  
(Co-supervisor)  
M. Dip: Chiro, CCFC,  
CCSP

**APPENDIX N: Informed Consent Form****INFORMED CONSENT FORM**  
(To be completed by patient / subject)**DATE:****TITLE OF RESEARCH PROJECT: An Investigation to establish an injury profile in South African cyclists and it's association to bicycle set-up.****NAME OF SUPERVISOR :Dr C. M.Korporaal****NAME OF CO-SUPERVISOR :Dr. A. Jones****NAME OF RESEARCH STUDENT :Barry Mills****Please circle the appropriate answer**

- |  | <b>YES /NO</b> |
|--|----------------|
| 10. Have you read the research information sheet?  | Yes No         |
| 11. Have you had an opportunity to ask questions regarding this study?   | Yes No         |
| 12. Have you received satisfactory answers to your questions?  | Yes No         |
| 13. Have you had an opportunity to discuss this study?   | Yes No         |
| 14. Have you received enough information about this study?   | Yes No         |
| 15. Do you understand the implications of your involvement in this study?  | Yes No         |
| 16. Do you understand that you are free to   |                |
| a) withdraw from this study at any time?   | Yes No         |
| b) withdraw from the study at any time, without reasons given  | Yes No         |
| c) withdraw from the study at any time without affecting your future health care or relationship with the Chiropractic day clinic at the Durban Institute of Technology. | Yes No         |
| 17. Do you agree to voluntarily participate in this study  | Yes No         |
| 18. Who have you spoken to regarding this study?   |                |

**If you have answered NO to any of the above, please obtain the necessary information from the researcher and / or supervisor before signing. Thank You.**

**Please Print in block letters:**

Participant Name: \_\_\_\_\_ Signature: \_\_\_\_\_

Witness Name: \_\_\_\_\_ Signature: \_\_\_\_\_

Researcher's Name: \_\_\_\_\_ Signature: \_\_\_\_\_

Supervisor's /  
Co-supervisor's Name: \_\_\_\_\_ Signature: \_\_\_\_\_

## APPENDIX O:DETAILS OF CYCLISTS

Table 4.4: Cyclist and bike characteristics for gender and bicycle groups. Data presented as number of patients in each category and group.

Parameter		Total	Male		Female	
			Road	Mountain	Road	Mountain
Current exercise						
Cross train	yes	77	26	17	18	16
	no	48	23	8	7	10
Core stability exercise	yes	77	32	12	11	22
	no	48	17	13	14	4
Sports history						
run	yes	91	41	19	14	17
	no	34	8	6	11	9
swim	yes	66	29	12	16	9
	no	59	20	13	9	17
triathlon	yes	19	12	1	3	3
	no	106	37	24	22	23
racquet	yes	49	18	13	8	10
	no	76	31	12	17	16
rugby	yes	48	29	16	3	0
	no	77	20	9	22	26
soccer	yes	27	19	7	1	0
	no	98	30	18	24	26
cricket	yes	22	14	8	0	0
	no	103	35	17	25	26
hockey	yes	25	3	2	10	10
	no	100	46	23	15	16
netball	yes	22	0	0	12	10
	no	103	49	25	13	16
Cycling related						

---

Push big gears or spin	Big gears	60	23	16	13	8
	Spin	65	26	9	12	18
% hills standing	0-25	95	37	17	21	20
	26-50	19	7	5	3	4
	51-75	3	1	1	0	1
	76-100	8	4	2	1	1
Frame size	Small	24	6	1	12	5
	Medium	43	11	9	11	12
	Large	26	14	5	2	5
	X-large	32	18	10	0	4
Frame material	Aluminium	104	40	20	23	21
	Chromoly	9	0	5	0	4
	Carbon fibre	10	8	0	1	1
	Titanium	2	1	0	1	0
Saddle type	Gel	1	0	1	0	0
	Cut-out	49	19	10	11	9
	Carbon fibre	1	1	0	0	0
	Wide back	12	1	5	2	4
	Narrow back	52	28	9	6	9
	Woman- specific	10	0	0	6	4
Seat position	Forward	24	11	2	6	5
	Central	71	23	18	13	17
	Back	30	15	5	6	4
Fork material	Aluminium	34	20	1	11	2
	Chromoly	15	2	6	2	5
	Carbon fibre	38	27	0	11	0
	Titanium	1	1	0	0	0
	Suspensio n	37	0	18	0	19

---

Pedal type	Cleat_floating	51	36	0	14	1
	Cleat_small	3	2	0	1	0
	Cleat_large	3	1	0	1	1
	SPD	30	8	9	7	6
	Cages	7	1	2	2	2
	Platform	31	1	14	0	16

Table 4.5: Cyclist and bike characteristics (mean  $\pm$  standard error) for gender and bicycle groups. Only continuous data are presented; see Table 3 for nominal data.

Parameter	Male		Female	
	Road	Mountain	Road	Mountain
Age (yr)	45.4 $\pm$ 1.6	34.5 $\pm$ 2.0	37.2 $\pm$ 1.7	36.5 $\pm$ 1.8
Height (cm)	178.1 $\pm$ 1.1	180.2 $\pm$ 1.6	164.6 $\pm$ 1.5	164.5 $\pm$ 1.4
Weight (kg)	83.3 $\pm$ 2.1	82.1 $\pm$ 2.4	64.6 $\pm$ 2.8	64.4 $\pm$ 2.4
Riding experience (yr)	7.3 $\pm$ 1.1	4.3 $\pm$ 0.6	3.0 $\pm$ 0.6	4.2 $\pm$ 1.7
km per week	208.3 $\pm$ 13.2	94.4 $\pm$ 7.3	147.6 $\pm$ 16.4	104.1 $\pm$ 11.0
hrs per week	7.6 $\pm$ 0.4	5.6 $\pm$ 0.5	6.4 $\pm$ 0.7	5.7 $\pm$ 0.6
Leg length inequality (actual; cm)	0.6 $\pm$ 0.1	0.7 $\pm$ 0.2	0.6 $\pm$ 0.1	0.3 $\pm$ 0.1
Leg length inequality (apparent; cm)	0.5 $\pm$ 0.1	0.5 $\pm$ 0.1	0.5 $\pm$ 0.1	0.4 $\pm$ 0.1
Shoulder width (cm)	33.1 $\pm$ 0.4	33.2 $\pm$ 0.6	28.7 $\pm$ 0.5	28.5 $\pm$ 0.4
Inseam (cm)	83.0 $\pm$ 0.7	84.3 $\pm$ 1.1	78.0 $\pm$ 1.0	77.7 $\pm$ 0.8
Torso (cm)	57.9 $\pm$ 0.7	57.0 $\pm$ 0.6	52.1 $\pm$ 0.7	53.4 $\pm$ 0.7
Seat height (from bottom bracket to seat; cm)	74.6 $\pm$ 0.7	75.0 $\pm$ 1.2	69.1 $\pm$ 0.9	67.5 $\pm$ 0.9
Handlebar width (cm)	44.8 $\pm$ 0.2	58.7 $\pm$ 0.7	43.8 $\pm$ 0.4	58.4 $\pm$ 0.8
Tire pressure (kPa)	837.4 $\pm$ 20.3	344.2 $\pm$ 14.2	748.0 $\pm$ 33.6	325.4 $\pm$ 22.3
Crank length (mm)	174.3 $\pm$ 0.2	174.8 $\pm$ 0.2	172.7 $\pm$ 0.5	173.9 $\pm$ 0.4



Stem length (mm)	103.6 ± 2.1	103.4 ± 2.5	92.6 ± 4.2	98.7 ± 3.2
Stem angle (°)	94.4 ± 2.0	119.2 ± 3.2	96.4 ± 4.1	124.6 ± 3.2
Top tube (cm)	53.6 ± 0.4	56.0 ± 0.9	51.4 ± 0.4	53.3 ± 0.5
(Seat tube + crank length) – Inseam*1.09 (cm)	1.6 ± 0.4	0.7 ± 0.8	1.4 ± 0.7	0.2 ± 0.8
Seat tube – inseam*0.883 (cm)	1.3 ± 0.4	0.6 ± 0.7	0.2 ± 0.6	-1.1 ± 0.7
Handlebar width – shoulder width (cm)	11.7 ± 0.4	25.6 ± 0.9	15.1 ± 0.6	30.0 ± 0.9
Crank – optimal crank_inseam (mm)	5.5 ± 0.8	4.1 ± 1.3	8.9 ± 1.2	10.4 ± 0.9
Crank – optimal crank_height (mm)	3.6 ± 0.4	3.2 ± 0.5	5.2 ± 0.7	6.2 ± 0.7

